

YAESU
The radio

FM TRANSCEIVER

FT-2980R/E

Operating Manual



Index

Introduction	1	Memory Tuning	34
About this manual	1	Masking Memories	34
Safety Precautions	2	Memory Bank Operation	35
Accessories & Options	4	Home Channel Memory	37
Supplied Accessories	4	Memory-Only Mode	37
Optional Accessories	4	Scanning	38
Front Panel Controls & Switches	5	Basic Scanner Operation	38
Microphone Switches	7	Scan-Resume Options	39
Rear Panel Connectors	8	Memory Skip Scanning	39
Installation	9	Preferential Memory Scan	40
Preliminary Inspection	9	Memory Bank Link Scan	41
Installation Tips	9	Programmable Band-Scan Limits	41
Antenna Consideration	10	Priority Channel Scanning (Dual Watch).....	42
About coaxial cable	10	Weather Alert Scan	43
Mobile Installation	10	Band Edge Beeper.....	43
Base Station Installation	12	Smart Search Operation	44
Basic Operation	13	Internet Connection Feature	45
Turning the Transceiver On and Off.....	13	SRG (“Sister Radio Group”) Mode.....	45
Adjusting the Audio Volume Level.....	13	FRG (“Friends’ Radio Group”) Mode.....	45
Adjusting the Squelch Setting.....	13	ARTS™ (Automatic Range	
Frequency Navigation	14	Transponder System)	48
Transmission	15	CW Training Feature	51
Advanced Operation	16	Packet Operation	52
Weather Broadcast Reception (USA Version) ..	16	Miscellaneous Settings	53
LOCK Feature.....	17	Password	53
Keyboard Beeper	17	Time-Out Timer (TOT).....	54
Channel Step Selection	18	Automatic Power-Off (APO).....	54
Display Brightness	18	Busy Channel Lock-Out (BCLO).....	55
RF Squelch	18	Programming the Key Assignments.....	56
Repeater Operation	19	FM Bandwidth & TX Deviation Level	57
Standard Repeater Shift	19	MIC Gain Setting.....	57
Automatic Repeater Shift	20	DCS Code Inversion	58
Checking the Repeater		Reset Procedure	59
Uplink (Input) Frequency.....	20	Microprocessor Resetting	59
CTCSS/DCS/EPCS Operation	21	Set Mode Resetting	59
CTCSS Operation	21	Cloning	60
DCS Operation.....	23	“Set” (Menu) Mode	61
Tone Search Scanning.....	24	Menu Selection Details	64
EPCS (Enhanced Paging &		Maintenance	72
Code Squelch) Operation	25	Storage of packing	
CTCSS/DCS/EPCS Bell Operation.....	27	Materials and transportation	72
Split Tone Operation	27	Specifications	73
DTMF Operation	28	After-market Services	74
Manual DTMF Tone Generation.....	28		
DTMF Autodialer	28		
Memory Operation	30		
Memory Storage	30		
Storing Independent Transmit			
Frequencies (“Odd Splits”).....	31		
Memory Recall	32		
Labeling Memories.....	33		

② [VOL KNOB]

Adjusts the audio volume level.

③ [SQL KNOB]

Adjust to the point where the background noise is muted.

④ [FREQUENCY DIAL KNOB]

Selects the operating Frequency.

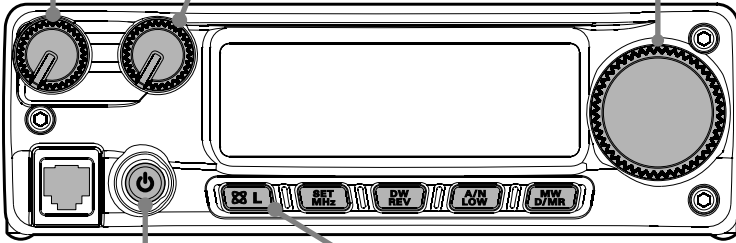

① [POWER SWITCH]

Press and hold for one second.

⑤ [LOCK SWITCH]

Press and hold for one second to lock all key functions except the **VOL**, **SQL** knobs and **PTT** switch.

⑥ [TRANSMISSION SWITCH]



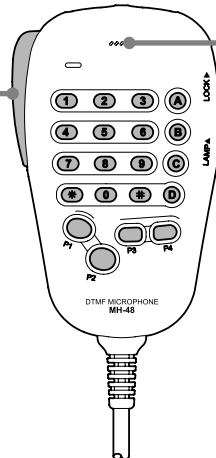

Speak into the microphone in a normal voice level while pressing this switch.

[MICROPHONE]



FT-2980R/E Quick Reference Guide

Key Overview

Key	Press Key Briefly	Press and Hold Key
	Activates the Internet Connection Feature.	Locks out the switches and knobs (except the VOL, SQL knobs and PTT switch).
	Allows tuning the VFO frequency in 1-MHz steps, or tuning channels in 10 channel steps.	Enters the Set (“Menu”) mode.
	Reverses transmit and receive frequencies in repeater operation.	Activates the Priority Channel Scanning (Dual Watch feature).
	Selects the transmitter power output level.	Toggles the display indication between “frequency” and the channel’s “Alpha/Numeric Tag”.
	Switches the frequency control between the VFO, Memory System, and the Home channel.	Transfers the VFO contents into a Memory register.

The Yaesu **FT-2980R/E** is a deluxe, rugged FM mobile transceiver providing high power output and outstanding receiver performance for the 144 MHz Amateur band. Included in the **FT-2980R/E**'s feature complement are:

- 80 Watts of power output, with selection of four power levels for every operating situation.
- Keyboard entry of operating frequencies from the microphone.
- Excellent protection from receiver intermodulation distortion, thanks to Yaesu's renowned Advanced Track Tuning front end.
- 221 memories (200 "basic" memory channels, 10 sets of band-edge memory channels, and one "Home" channel) which can store repeater shifts, odd repeater shifts, CTCSS/DCS tones, and 6-character Alpha-Numeric labels for easy channel recognition.
- 10 NOAA Weather Broadcast Channels, with Weather Alert and a Volume Control for the Weather Alert tone.
- Built-in CTCSS and DCS Encoder/Decoder circuits.
- The Smart Search™ feature, which automatically sweeps a band and loads active frequencies into dedicated memory banks, is ideal for identifying active repeaters when visiting a city for the first time.
- Extensive Menu system, which allows customization of a number of transceiver performance characteristics.
- The Yaesu-exclusive multi-function LCD display.



Additional features include a transmit Time-Out-Timer (TOT), Automatic Power-Off (APO), Automatic Repeater Shift (ARS), plus provision for reduction of the Tx deviation in areas of high channel congestion. And an RF Squelch circuit allows the owner to set the squelch to open at a programmable setting of the S-Meter, thus reducing guesswork in setting the squelch threshold.

Congratulations on your purchase of the **FT-2980R/E**! Whether this is your first rig, or if Yaesu equipment is already the backbone of your station, the Yaesu organization is committed to ensuring your enjoyment of this high-performance transceiver, which should provide you with many years of satisfying operation. Our dealer network and technical support personnel stand behind every product we sell, and we invite you to contact us should you require technical advice or assistance.

We recommend that you read this manual in its entirety prior to installing the **FT-2980R/E**, so that you fully understand the capabilities of your new transceiver.

About this manual

This manual contains symbols and conventions to call attention to important information.

Symbols	Description
	This icon indicates cautions and alerts the user should be aware of.
	This icon indicates helpful notes, tips and information.

Safety Precautions

Note beforehand that the company shall not be liable for any damages suffered by the customer or third parties in using this product, or for any failures and faults that occur during the use or misuse of this product, unless otherwise provided for under the law.

Type and meaning of the marks



DANGER

This symbol indicates the possibility of death or serious injury being inflicted on the user and the surrounding people when these instructions are ignored and the product is mishandled.



WARNING

This symbol indicates the possibility of death or serious injury being inflicted on the user and the surrounding people when these instructions are ignored and the product is mishandled.



CAUTION

This symbol indicates the possibility of physical impediments occurring or impediments being inflicted on the user and the surrounding people when these instructions are ignored and the product is mishandled.

Type and meaning of symbols



Prohibited actions that must not be attempted, in order to use this radio safely. For example,  signifies that disassembly is prohibited.



Precautions that must be adhered to in order to use this radio safely. For example,  signifies that the power supply is to be disconnected.



DANGER



Do not use the device in “regions or aircrafts and vehicles where its use is prohibited” such as in hospitals and airplanes. This may exert an impact on electronic and medical devices.



Do not use this product while driving or riding a motorbike. This may result in accidents. Make sure to stop the car in a safe location first before use if the device is going to be used by the driver.



Never touch the antenna during transmission. This may result in injury, electric shock and equipment failure.



Do not operate the device when flammable gas is generated. Doing so may result in fire and explosion.



Do not transmit in crowded places in consideration of people who are fitted with medical devices such as heart pacemakers. Electromagnetic waves from the device may affect the medical device, resulting in accidents caused by malfunctions.



Do not touch any liquid leaking from the liquid display with your bare hands. There is a risk of chemical burns occurring when the liquid comes into contact with the skin or gets into the eyes. In this case, seek medical treatment immediately.



WARNING



Do not use voltages other than the specified power supply voltage. Doing so may result in fire and electric shock.



Do not transmit continuously for long periods of time. This may cause the temperature of the main body to rise and result in burns and failures due to overheating.



Do not dismantle or modify the device. This may result in injury, electric shock and equipment failure.



Do not handle the power plug and connector etc. with wet hands. Also do not plug and unplug the power plug with wet hands. This may result in injury, liquid leak, electric shock and equipment failure.



When smoke or strange odors are emitted from the radio, turn off the power and disconnect the power cord from the socket.

This may result in fire, liquid leak, overheating, damage, ignition and equipment failure. Please contact our company amateur customer support or the retail store where you purchased the device.



Keep the power plug pins and the surrounding areas clean at all times. This may result in fire, liquid leak, overheating, breakage, ignition etc.



Disconnect the power cord and connection cables before incorporating items sold separately and replacing the fuse. This may result in fire, electric shock and equipment failure.

Safety Precautions



Never cut off the fuse holder of the DC power cord.
This may cause short-circuiting and result in ignition and fire.



Do not use fuses other than those specified.
Doing so may result in fire and equipment failure.



Do not allow metallic objects such as wires and water to get inside the product.
This may result in fire, electric shock and equipment failure.



Do not place the device in areas that may get wet easily (e.g. near a humidifier).
This may result in fire, electric shock and equipment failure.



When connecting a DC power cord, pay due care not to mix up the positive and negative polarities.
This may result in fire, electric shock and equipment failure.



Do not use DC power cords other than the one enclosed or specified.
This may result in fire, electric shock and equipment failure.



Do not bend, twist, pull, heat and modify the power cord and connection cables in an unreasonable manner.
This may cut or damage the cables and result in fire, electric shock and equipment failure.



Do not pull the cable when plugging and unplugging the power cord and connection cables.
Please hold the plug or connector when unplugging. If not, this may result in fire, electric shock and equipment failure.



Refrain from using headphones and earphones at a loud volume.
Continuous exposure to loud volumes may result in hearing impairment.



Do not use the device when the power cord and connection cables are damaged, and when the DC power connector cannot be plugged in tightly.
Please contact YAESU Technical Support or the retail store where you purchased the device as this may result in fire, electric shock and equipment failure.



Follow the instructions given when installing items sold separately and replacing the fuse.
This may result in fire, electric shock and equipment failure.



CAUTION



Do not place this device near a heating instrument or in a location exposed to direct sunlight.
This may result in deformation and discoloration.



Do not place this device in a location where there is a lot of dust and humidity.
Doing so may result in fire and equipment failure.



Stay as far away from the antenna as possible during transmission.
Long-term exposure to electromagnetic radiation may have a negative effect on the human body.



Do not wipe the case using thinner and benzene etc.
Please use a soft and dry piece of cloth to wipe away the stains on the case.



Keep out of the reach of small children.
If not, this may result in injuries to children.



Do not put heavy objects on top of the power cord and connection cables.
This may damage the power cord and connection cables, resulting in fire and electric shock.



Do not transmit near the television and radio.
This may result in electromagnetic interference.



Do not use optional products other than those specified by our company.
If not, this may result in equipment failure.



When using the device in a hybrid car or fuel-saving car, make sure to check with the car manufacturer before using.
The device may not be able to receive transmissions normally due to the influence of noises from the electrical devices (inverters etc.) fitted in the car.



For safety reasons, switch off the power and pull out the DC power cord connected to the DC power connector when the device is not going to be used for a long period of time.
If not, this may result in fire and overheating.



Do not throw or subject the device to strong impact forces.
This may result in equipment failure.



Do not put this device near magnetic cards and video tapes.
The data in the cash card and video tape etc. may be erased.



Do not turn on the volume too high when using a headphone or earphone.
This may result in hearing impairment.



Do not place the device on an unsteady or sloping surface, or in a location where there is a lot of vibration.
The device may fall over or drop, resulting in fire, injury and equipment failure.

Safety Precautions



Do not stand on top of the product, and do not place heavy objects on top or insert objects inside it.

If not, this may result in equipment failure.



Do not use a microphone other than those specified when connecting a microphone to the device.

If not, this may result in equipment failure.



Do not touch the heat radiating parts.

When used for a long period of time, the temperature of the heat radiating parts will get higher, resulting in burns when touched.



Do not open the case of the product except when replacing the fuse and when installing items sold separately.

This may result in injury, electric shock and equipment failure.

Accessories & Options

Supplied Accessories

Microphone MH-48A6JA	1
Mobile Mounting Bracket MMB-83	1
DC Power Cord w/Fuse	1
Spare Fuse 25A (USA/Asian version)	2
Spare Fuse 20A (European version)	2
Standing Foot	2
Operating Manual	1
Warranty Card	1

Optional Accessories

High-Power External Speaker	MLS-100
AC Power Supply	FP-1023 (23 A: USA market only)
AC Power Supply	FP-1030A

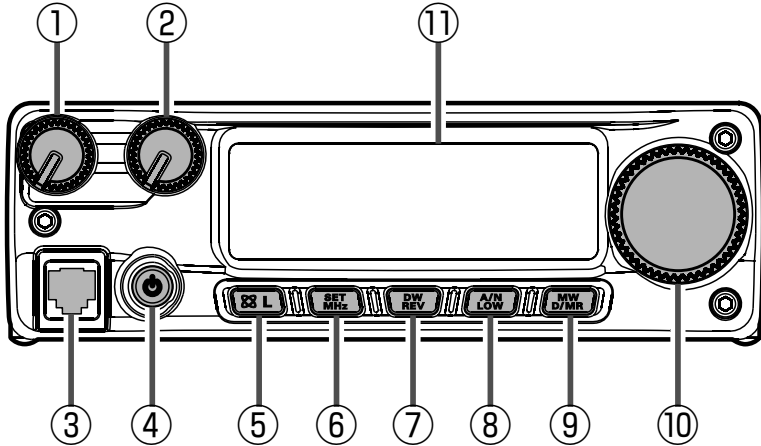

① VOL Knob

This control adjusts the audio volume level. Clockwise rotation increases the volume level.

② SQL Knob

This control is used to silence background noise on the receiver. It should be advanced clockwise just to the point where the noise is silenced (and the **"BUSY"** indicator on the display turns off), so as to provide the best sensitivity to weak signals.

③ Microphone Jack

Connect the supplied **MH-48A6J** Hand Microphone to this jack.

④ PWR Key

Press and hold this key for one second to toggle the transceiver's power on and off.

⑤ [L] Key

This key allows operation in conjunction with the Internet Connection feature.

Press and hold in this key for one second to toggle the Lockout Feature "on" or "off".

⑥ [MHz(SET)] Key

This key allows tuning in 1-MHz steps (the MHz digits will blink on the display). If receiving on a memory, pressing this key the first time activates the Memory Tuning mode, and pressing it again enables 1-MHz steps.

Press and hold in this key for one second to activate the "Set" (Menu) mode.

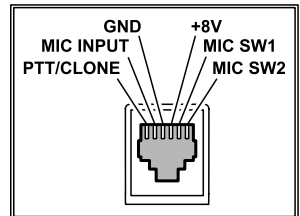

Front Panel Controls & Switches

⑦ [REV(DW)] Key

During split-frequency operation, such as through a repeater, this key reverses the transmit and receive frequencies.

Press and hold in this key for one second to activate the Dual Watch feature, described in the Operation chapter (“PRI” will be displayed on the LCD, indicating “Priority Channel” monitoring).

⑧ [LOW(A/N)] Key

Press this key momentarily to select the transmitter power output level. The available power levels are:

LOW1 (5 W) ➡ LOW2 (10 W) ➡ LOW3 (30 W) ➡ HIGH (80 W)

To toggle the display between indication of the frequency and the channel’s Alpha/Numeric label, press and hold in this key for one second while receiving on that memory channel.

⑨ [D/MR(MW)] Key

Press this key momentarily to switch the frequency control among the VFO, Memory System, and Home channel.

Press and hold in this key for one second to activate the Memory Storage mode.

⑩ DIAL Knob

This 24-position detented rotary switch is used for tuning, memory selection and most function settings. The microphone [UP]/[DWN] buttons duplicate the functions of this knob.

⑪ Display

The main digits on the display may show the operating frequency, memory name, or any of many parameters during Menu setup.

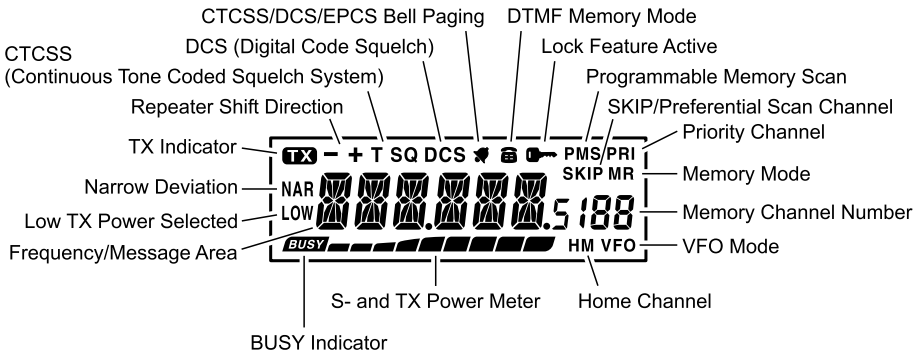

① PTT Switch

Press this switch to transmit, and release it to receive.

② Keypad

These 16 keys generate DTMF tones during transmission.

In the receive mode, these 16 keys can be used for direct frequency entry and/or direct numeric recall of the Memory channels.

The [A], [B], [C], and [D] keys, on receive, replicate the functions of the front panel keys ([MHz(SET)], [REV(DW)], [LOW(A/N)], and [D/MR(MW)]). See the previous discussion.

③ [P1]/[P2]/[P3]/[P4] Buttons

These four keys are user programmable, allowing quick access to features used often. The default functions are described below.

[P1] button (SQL OFF)

Press this button to disable the noise and tone squelch systems.

[P2] button (S SRCH)

Press this button to activate the Smart Search feature.

[P3] button (C SRCH)

Press this button to activate the Tone Search feature.

[P4] button (WX CH/T.CALL)

In the USA version, pressing this button recalls the “Weather” broadcast channel bank. In the Asian/European version, pressing this button activates T.CALL (1750 Hz) for repeater access.

You can reprogram the [P1], [P2], [P3], and [P4] buttons for other functions, if desired. See page 56 for details.

④ LAMP Switch

This switch illuminates the Microphone’s keypad.

⑤ LOCK Switch

This switch locks out the Microphone’s buttons (except for the keypad and PTT switch).

⑥ [UP]/[DWN] Button

Press (or hold in) either of these buttons to tune (or scan up or down) the operating frequency or through the memory channels. In many ways, these buttons emulate the function of the (rotary) DIAL knob.

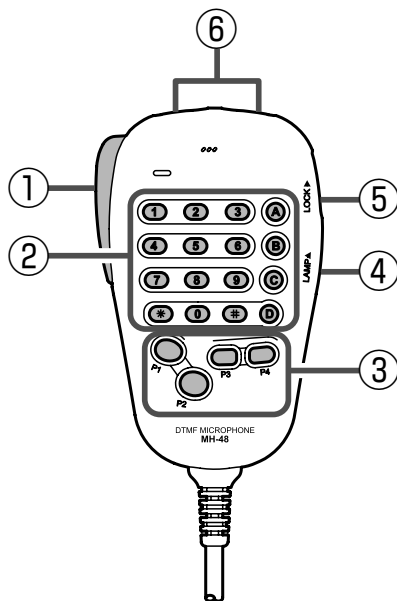

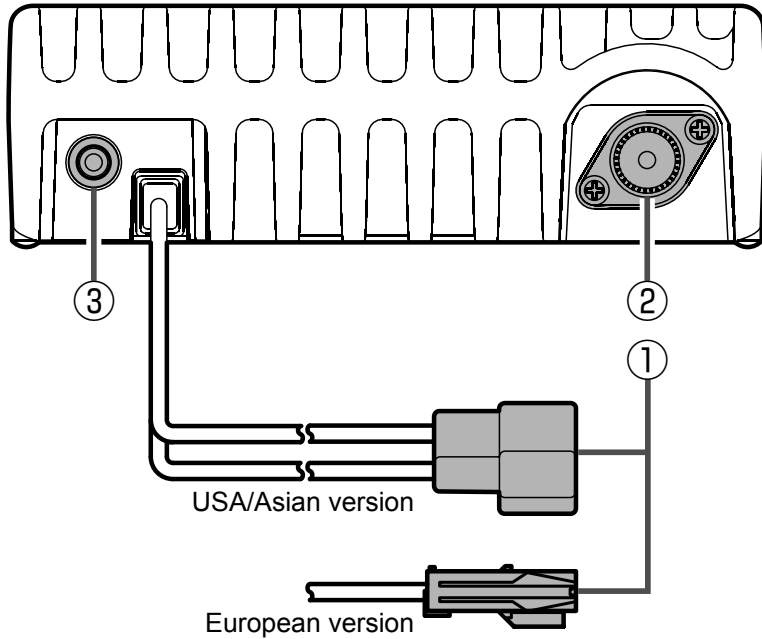

① 13.8V DC Cable Pigtail

This is the power supply connection for the transceiver. Use the supplied DC cable to connect this pigtail to the car battery or other DC power supply capable of at least 15 Amperes (continuous duty). Make certain that the red lead connects to the positive side of the supply. The fuse is 25 A (USA/Asian version) or 20 A (European version).

② ANT Coaxial Socket

Connect a 144-MHz antenna to this type-M (SO-239) socket using 50-Ohm coaxial cable and a type-M (PL-259) plug. Make sure the antenna is designed specifically for use on the operating frequency.

③ EXT SP Jack

This 2-contact 3.5-mm mini phone jack provides receiver audio output for an optional external speaker. The audio impedance is 4 Ohms, and the level varies according to the setting of the front panel's **VOL** control. Inserting a plug into this jack disables audio from the transceiver's internal speaker.

This chapter describes the installation procedure for integrating the **FT-2980R/E** into a typical amateur radio station. It is presumed that you possess technical knowledge and conceptual understanding consistent with your status as a licensed radio amateur. Please take some extra time to make certain that the important safety and technical requirements detailed in this chapter are followed closely.

Preliminary Inspection

Inspect the transceiver visually immediately upon opening the packing carton. Confirm that all controls and switches work freely, and inspect the cabinet for any damage. Gently shake the transceiver to verify that no internal components have been shaken loose due to rough handling during shipping.

If any evidence of damage is discovered, document it thoroughly and contact the shipping company (or your local dealer, if the unit was purchased over-the-counter) so as to get instructions regarding the prompt resolution of the damage situation. Be certain to save the shipping carton, especially if there are any punctures or other evidence of damage incurred during shipping; if it is necessary to return the unit for service or replacement, use the original packing materials but put the entire package inside another packing carton, so as to preserve the evidence of shipping damage for insurance purposes.

Installation Tips

To ensure long life of the components, be certain to provide adequate ventilation around the cabinet of the **FT-2980R/E**.

Do not install the transceiver on top of another heat-generating device (such as a power supply or amplifier), and do not place equipment, books, or papers on top of the **FT-2980R/E**. Avoid heating vents and window locations that could expose the transceiver to excessive direct sunlight, especially in hot climates. The **FT-2980R/E** should not be used in an environment where the ambient temperature exceeds +140 °F (+60 °C).

Installation

Antenna Consideration

The **FT-2980R/E** is designed for 50 Ohm resistive impedance at the amateur operating frequencies.

The antenna (or a 50 Ohm dummy load) should be connected whenever the transceiver is turned on, to avoid damage that could otherwise result if transmission occurs accidentally without an antenna.

Ensure that your antenna is designed to handle 80 Watts of transmitter power. Some magnetic-mount mobile antennas, designed for use with hand-held transceivers, may not be capable of withstanding this power level. Consult the antenna manufacturer's specification sheet for details.

Construct the antenna and coaxial cable, to maintain the impedance presented to the **FT-2980R/E** antenna connector for an SWR of 1.5 or less. Careful preparation of the antenna will permit maximum performance and protect the transceiver from damage. High voltages may be present on the antenna; install it so it will not be easily touched when in operation.

About coaxial cable

Use high-quality 50-Ohm coaxial cable for the lead-in to your **FT-2980R/E** transceiver.

Mobile Installation

The **FT-2980R/E** must only be installed in vehicles having a 13.8 Volt negative ground electrical system. Mount the transceiver where the display, controls, and microphone are easily accessible, using the supplied **MMB-83** mounting bracket.

The transceiver may be installed in almost any location, but should not be positioned near a heating vent nor anywhere where it might interfere with driving (either visually or mechanically). Make sure to provide plenty of space on all sides of the transceiver so that air can flow freely around the radio's case. Refer to the diagrams showing proper installation procedures.

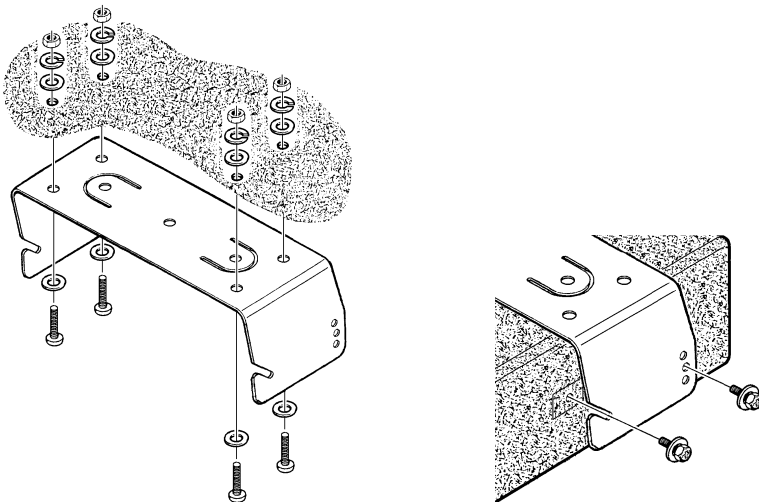

Mobile Power Connections

To minimize voltage drop and avoid blowing the vehicle's fuses, connect the supplied DC power cable directly to the battery terminals. Do not attempt to defeat or bypass the DC cable's fuse - it is there to protect you, your transceiver, and your vehicle's electrical system.

Warning!

Never apply AC power to the power cable of the FT-2980R/E, nor DC voltage greater than 15.8 Volts. When replacing the fuse, only use a 25-A (USA/Asian version) or 20-A (European version) fuse. Failure to observe these safety precautions will void the Limited Warranty on this product.

- ❑ Use the transceiver only in a car with a negative ground 12 V DC system, where the minus (-) pole of the battery is connected to the car body.
- ❑ Do not connect the radio to the 24 V battery of a large vehicle.
- ❑ Do not use a DC power cable other than the one that is supplied or specified.
- ❑ High current is carried during transmissions; do not use the cigarette lighter connector inside the car as a power source.

 High RF voltage is present in the TX RF section of the transceiver while transmitting. Absolutely! Do not touch the TX RF section while transmitting.

 Permanent damage can result when improper supply voltage, or reverse polarity voltage, is applied to the FT-2980R/E. The Limited Warranty on this transceiver does not cover damage caused by application of AC voltage, reverse polarity DC, or DC voltage outside the specified range of 13.8 V \pm 15 %. When replacing fuses, be certain to use a fuse of the proper rating.

The FT-2980R/E requires a 25 Amp (USA/Asian version) or 20 Amp (European version) blade fuse.

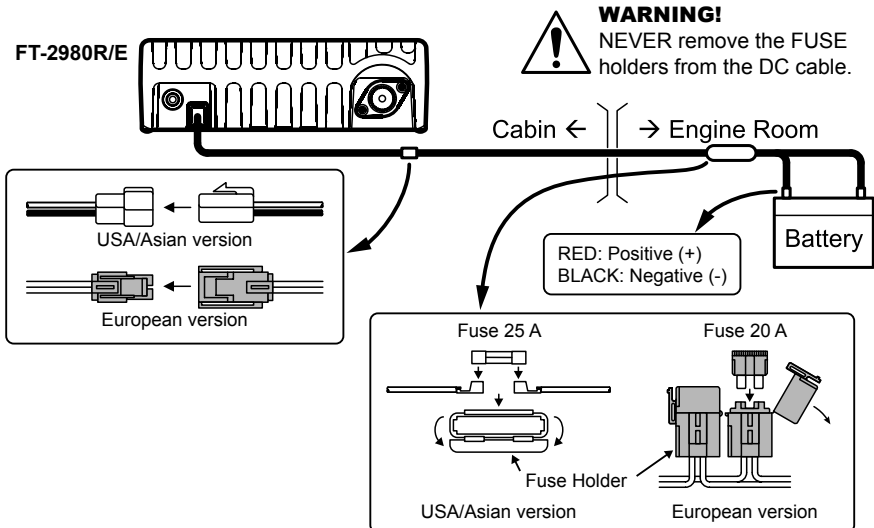

Installation

Mobile Speakers

The optional **MLS-100** External Speaker includes its own swivel-type mounting bracket, and is available from your Yaesu dealer.

Other external speakers may be used with the **FT-2980R/E**, if they present the specified 4-Ohm impedance and are capable of handling the 3 Watts of audio output supplied by the **FT-2980R/E**.

Base Station Installation

The **FT-2980R/E** is ideal for base station use as well as in mobile installations. The **FT-2980R/E** is specifically designed to integrate into your station easily, using the information to follow as a reference.

AC Power Supplies

Operation of the **FT-2980R/E** from an AC line requires a power source capable of providing at least 15 Amps continuously at 13.8 Volts DC. The **FP-1023** (USA market only) and **FP-1030A** AC Power Supplies are available from your Yaesu dealer to satisfy these requirements. Other well-regulated power supplies may be used, as well, if they meet the above voltage and current specifications.

Use the DC power cable supplied with your transceiver for making power connections to the power supply. Connect the **RED** power cable lead to the **POSITIVE (+)** power supply terminal, and connect the **BLACK** power cable lead to the **NEGATIVE (-)** power supply terminal.

Base Station Feet

The supplied Base Station Feet allow the transceiver to be tilted upward for better viewing. To install the Base Station Feet, remove the two screws affixing the front side of the bottom cover, then install the Base Station Feet using these screws.

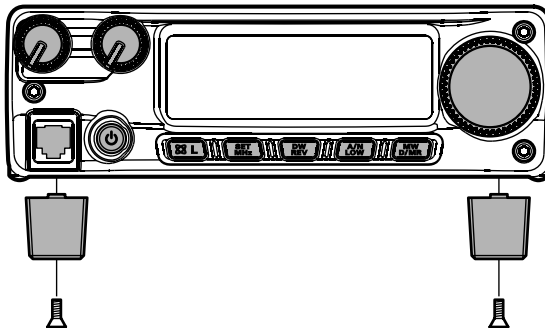

Turning the Transceiver On and Off

1. To turn the transceiver on, press and hold in the **PWR** key for one second.
When you turn on the **FT-2980R/E**, the current DC supply voltage is indicated on the LCD for 2 seconds. After this interval, the display will switch its normal indication of the operating frequency.
2. To turn the transceiver off, again press and hold in the **PWR** key for one second.

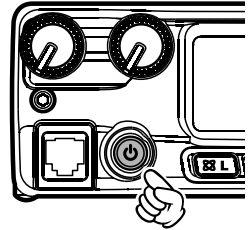

 You can change the Opening Message (DC supply voltage indication) to any desired message (up to 6 characters) via Set Mode Item “31 OPN.MSG;” see page 67 for details.

Adjusting the Audio Volume Level

Rotate the **VOL** control to adjust the receiver volume. Clockwise rotation increases the audio output level.

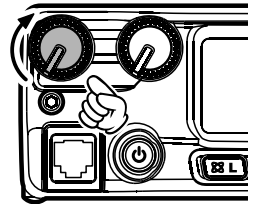

Adjusting the Squelch Setting

Rotate the **SQL** control just to the point where the noise is silenced and the “**BUSY**” indicator on the display turns off. If the **SQL** control is set further clockwise, sensitivity to weak signals is reduced.

A special “**RF Squelch**” feature is provided on this radio. This feature allows you to set the squelch so that only signals exceeding a certain S-meter level will open the squelch. See page 18 for details

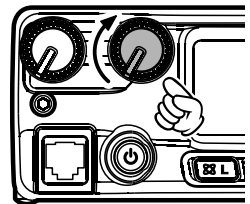

Frequency Navigation

1) Tuning Dial

Rotating the **DIAL** knob allows tuning in the pre-programmed steps. Clockwise rotation of the **DIAL** knob causes the **FT-2980R/E** to be tuned toward a higher frequency, while counter-clockwise rotation will lower the operating frequency.

Press the [**MHz(SET)**] key momentarily, then rotate the **DIAL** knob, to change the frequency steps to 1 MHz per step. This feature is extremely useful for making rapid frequency excursions over the wide tuning range of the **FT-2980R/E**. Instead of pressing the [**MHz(SET)**] button, you may also press the [**A**] key on the Microphone's keypad to engage tuning in 1 MHz steps.

2) Direct Keypad Frequency Entry

The keypad of the **MH-48A6J** DTMF Microphone may be used for direct entry of the operating frequency.

To enter a frequency from the **MH-48A6J** keypad, just press the numbered digits in the proper sequence. There is no "decimal point" key on the **MH-48A6J** keypad. However, there is a short-cut for frequencies ending in zero: press the [**#**] key after the last non-zero digit.

Examples: To enter 145.520 MHz, press [1] ➡ [4] ➡ [4] ➡ [5] ➡ [2] ➡ [0]

To enter 145.000 MHz, press [1] ➡ [4] ➡ [5] ➡ [**#**]



If you cannot get the radio to accept the frequency entry, it is possible that the channel steps are set to an incompatible value (e.g. if you have 25 kHz steps set, you cannot set a frequency of 145.520 MHz). See page 18 to learn how to change the channel step size.

3) Scanning

From the VFO mode, press the microphone's [**UP**]/[**DWN**] keys momentarily to initiate scanning toward a higher- or lower frequency, respectively. The **FT-2980R/E** will stop when it receives a signal strong enough to break through the squelch threshold. The **FT-2980R/E** will then hold on that frequency according to the setting of the "Resume" mode (Menu "41 SCAN"); see page 39).

If you wish to reverse the direction of the scan (i.e. toward a lower frequency, instead of a higher frequency), just rotate the **DIAL** knob one click in the counter-clockwise direction while the **FT-2980R/E** is scanning. The scanning direction will be reversed. To revert to scanning toward a higher frequency once more, rotate the **DIAL** knob one click clockwise. Press the [**UP**]/[**DWN**] keys again to cancel scanning. You may also press the **PTT** button momentarily; scanning will stop, but you will not transmit until you release the **PTT** button, and press it again.



If you have enabled the "Severe Weather Alert" feature, you will occasionally notice "WX" channels interspersed with the regular channels you are scanning. This is normal, because your radio is constantly monitoring for weather alerts. See page 16.

Transmission

To transmit, simply close the **PTT** (Push To Talk) switch on the microphone when the frequency is clear. Hold the microphone approximately 1" (25 mm) from your mouth, and speak into the microphone in a normal voice level. When your transmission is complete, release the **PTT** switch; the transceiver will revert to the receive mode.

During transmission, the "**TX**" indicator will appear at the upper left corner on the display.

Changing the Transmitter Power Level

You can select from among a total of four transmit power levels on your **FT-2980R/E**.

To change the power level, press the [**LOW(A/N)**] key (or the microphone's [**C**] key) to select one of four power settings. These power levels will be stored, in memory registers, at the time of memory storage (see page 30 for details on Memory operation).

During transmission, the Bar Graph will deflect in the display, according to the power output selected.

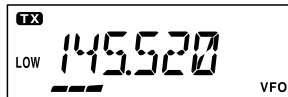

Low 1 (5 watts)



Low 2 (10 watts)



Low 3 (30 watts)



HIGH (80 watts)

Advanced Operation

Weather Broadcast Reception (USA Version)

The **FT-2980R/E** includes a unique feature which allows reception of weather broadcasts in the 160 MHz frequency range. Ten standard Weather Broadcast channels are pre-loaded into a special memory bank.

To listen to a Weather Broadcast Channel:

1. Press the Microphone's **[P4]** button to recall the Weather Broadcast channels.
2. Turn the **DIAL** knob to select the desired Weather Broadcast channel.



CH	Frequency	CH	Frequency
01	162.550 MHz	06	162.500 MHz
02	162.400 MHz	07	162.525 MHz
03	162.475 MHz	08	161.650 MHz
04	162.425 MHz	09	161.775 MHz
05	162.450 MHz	10	163.275 MHz

3. If you wish to check the other channels for activity by scanning, just press the Microphone's **PTT** switch.
4. To exit to normal operation, press the **[P4]** button again. Operation will return to the VFO or Memory channel you were operating on before you began Weather Broadcast operation.

 **The [P4] key, one of the programmable keys, is assigned (default setting) as the “WX Broadcast” one-touch access key. Please note that if you change/assign another function to the [P4] key, one-touch access to the WX channel will be unavailable.**



Severe Weather Alert Feature

In the event of extreme weather disturbances, such as storms and hurricanes, NOAA (the National Oceanic and Atmospheric Administration) sends a weather alert accompanied by a 1050 Hz tone and subsequent weather report on one of the NOAA weather channels. You may enable this feature via Menu Item “57 WX ALT”, if desired. See page 43 for details.

When scanning the band or the “regular” memories, with the Severe Weather Alert feature engaged, you will notice that the **FT-2980R/E** will break over to the Weather Channel bank every five seconds, performing a quick scan of those channels in search for the 1050 Hz alert tone. If the alert tone is received, operation will lock on the weather broadcast station issuing the alert; otherwise, the radio will revert to the VFO or memory scan session in progress without interruption.

When the alert tone is received, press the **PTT** button momentarily to disable the alarm, and the Severe Weather message will now be audible from the speaker.

LOCK Feature

To activate the locking feature, **press and hold** in the  key for one second. The  icon will appear on the LCD. To cancel locking, press and hold in the  key again for one second.

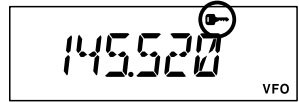

In order to prevent accidental frequency change or inadvertent transmission, various aspects of the **FT-2980R/E**'s keys and knob may be locked out.

To lock out some or all of the keys, use the "Set" (Menu) mode, described below:

1. Press and hold in the **[MHz(SET)]** key for one second, then rotate the **DIAL** knob to select "26 LOCK".
2. Press the **[MHz(SET)]** key, then rotate the **DIAL** knob to select the desired lockout combination.



- KEY: Just the front panel keys are locked out.
- DIAL: Just the front panel **DIAL** knob is locked out.
- K+D: Both the keys and **DIAL** knob are locked out.
- PTT: The **PTT** switch is locked (TX not possible).
- K+P: Both keys and **PTT** switch are locked out.
- D+P: Both **DIAL** knob and **PTT** switch are locked out.
- ALL: All of the above are locked out.

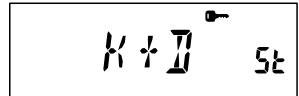

3. Press and hold in the **[MHz(SET)]** key for one second to save the new setting and exit to normal operation.

Keyboard Beeper

A key/button beeper provides useful audible feedback whenever a key/button is pressed. If you want to turn the beeper off (or back on again):

1. Press and hold in the **[MHz(SET)]** key for one second, then rotate the **DIAL** knob to select "6 BEEP".
2. Press the **[MHz(SET)]** key, then rotate the **DIAL** knob to set the display to "OFF".
3. Press and hold in the **[MHz(SET)]** key for one second to save your new setting and exit to normal operation.
4. To turn the beep back on again, select "KEY" or "KY+SCN (factory default)" in step 4 above.

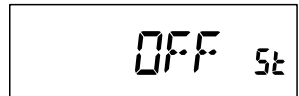

- KEY: The beeper sounds when you press the keypad.
- KY+SCN: The beeper sounds when you press the keypad, or when the scanner stops.

Advanced Operation

Channel Step Selection

Tuning steps are factory preset to default increments which are appropriate for the country to which this radio is exported. You may have a reason to use a different step size, however, and here is the procedure for changing the channel steps:

1. Press and hold in the **[MHz(SET)]** key for one second, then rotate the **DIAL** knob to select "50 STEP".
2. Press the **[MHz(SET)]** key, then rotate the **DIAL** knob to select the desired step size (5/10/12.5/15/20/25/50/100 kHz).
3. Press and hold in the **[MHz(SET)]** key for one second to save your new setting and exit to normal operation.



STEP 50



200K 5t

Display Brightness

The **FT-2980R/E** display illumination has been specially engineered to provide high visibility with minimal disruption of your "night vision" while you are driving. The brightness of the display is manually adjustable, using the following procedure:

1. Press and hold in the **[MHz(SET)]** key for one second, then rotate the **DIAL** knob to select "16 DIMMER".
2. Press the **[MHz(SET)]** key, then rotate the **DIAL** knob to select a comfortable brightness level (LVL 0 - LVL10).
3. Press and hold in the **[MHz(SET)]** key for one second to save your new setting and exit to normal operation.



DIMMER 16



LVL 5 5t

RF Squelch

A special RF Squelch feature is provided on this radio. This feature allows you to set the squelch so that only signals exceeding a certain S-meter level will open the squelch.

To set up the RF squelch circuit for operation, use the following procedure:

1. Press and hold in the **[MHz(SET)]** key for one second, then rotate the **DIAL** knob to select "42 RF SQL".
2. Press the **[MHz(SET)]** key, then rotate the **DIAL** knob to select the desired signal strength level for the squelch threshold (S1 - S9 or OFF).
3. Press and hold in the **[MHz(SET)]** key for one second to save your new setting and exit to normal operation.



RF SQL 42



S9 5t

 The receiver's squelch will open based on the highest level set by the two squelch systems, "Noise Squelch" and "RF Squelch". For example:

- 1) If the Noise Squelch (SQL control) is set so that signals at a level of S-3 will open the squelch, but the RF Squelch (Menu #42) is set to "S-9", the squelch will only open on signals which are S-9 or stronger on the S-meter.
- 2) If the RF Squelch is set to "S-3", but the Noise Squelch is set to a high level which will only pass signals which are Full Scale on the S-meter, the squelch will only open on signals which are Full Scale on the S-meter. In this case, the Noise Squelch overrides the action of the RF Squelch.

Repeater Operation

The **FT-2980R/E** includes a host of convenience features which makes operation on amateur repeaters both efficient and enjoyable.

This transceiver offers three methods of setting up split-frequency operation on repeaters:

- Manual selection of preset repeater shifts (Standard Repeater Shift);
- Automatic Repeater Shift (ARS), providing automatic activation of repeater shifts while operating within designated repeater frequency subbands; and
- Independently stored transmit and receive frequencies (typically not corresponding to established repeater frequency shifts).

Standard Repeater Shift

To activate the standard shift manually, you may use the Set (Menu) mode:

1. Press and hold in the **[MHz(SET)]** key for one second, then rotate the **DIAL** knob to select “43 RPT”.
2. Press the **[MHz(SET)]** key, then rotate the **DIAL** knob to select the desired shift direction (-RPT, +RPT, or SIMP).
3. Press and hold in the **[MHz(SET)]** key for one second to save your new setting and exit to normal operation.

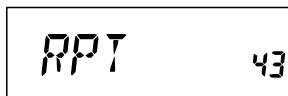

RPT 43

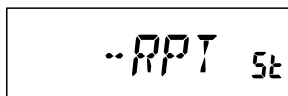

-RPT 5k

 **You also may program one of the Microphone's programmable keys ([P1] ~ [P4]) to allow quick access to the above procedure. See page 56 for details on the setup of the programmable keys.**

With repeater shift activated, you can temporarily reverse the transmit and receive frequencies by pressing the **[REV(DW)]** key (or the microphone's **[B]** key). Use this feature to display the transmit frequency *without transmitting*, and to check the strength of signals on a repeater uplink frequency (so as to determine whether or not a particular station is within “Simplex” range, for example).

The repeater offset is fixed to 600 kHz from the factory. You can change the offset by the following procedure, if needed for vacation travel or other purposes:

1. Press and hold in the **[MHz(SET)]** key for one second, then rotate the **DIAL** knob to select “46 SHIFT”.
2. Press the **[MHz(SET)]** key, then rotate the **DIAL** knob to set the desired offset. Note that the resolution of the “standard” repeater shift is to the nearest 50 kHz multiple.
3. Press and hold in the **[MHz(SET)]** key for one second to save your new setting and exit to normal operation.



SHIFT 46



0.60M 5k

 **Do not use this procedure for programming of an “odd split” type repeater pair! The process for programming odd splits is shown on page 31.**

Repeater Operation

Automatic Repeater Shift

The ARS (Automatic Repeater Shift) feature in this transceiver allows easy and convenient repeater operation by automatically activating the repeater shift function whenever you tune to a standard repeater subband. The ARS function is preset at the factory to conform to the standards for the country to which it is exported.

The ARS function is *enabled* at the factory. To *disable* it:

1. Press and hold in the **[MHz(SET)]** key for one second, then rotate the **DIAL** knob to select "4 ARS".
2. Press the **[MHz(SET)]** key, then rotate the **DIAL** knob to change the display to "OFF".
3. Press and hold in the **[MHz(SET)]** key for one second to save your new setting and exit to normal operation.



To enable the ARS function again, select "ON" in step 2 above.

Checking the Repeater Uplink (Input) Frequency

It often is helpful to be able to check the uplink (input) frequency of a repeater, to see if the calling station is within direct ("Simplex") range.

To do this, just press the **[REV(DW)]** key. You'll notice that the display has shifted to the repeater uplink frequency. Press the **[REV(DW)]** key again to cause operation to revert to normal monitoring of the repeater downlink (output) frequency. While you are listening on the input frequency to the repeater using the **[REV(DW)]** key, the repeater offset icon will blink.

CTCSS Operation

Many repeater systems require that a very-low-frequency audio tone be superimposed on your FM carrier in order to activate the repeater. This helps prevent false activation of the repeater by radar or spurious signals from other transmitters. This tone system, called “CTCSS” (Continuous Tone Coded Squelch System), is included in your **FT-2980R/E**, and is very easy to activate.

 **CTCSS setup involves two actions: setting the Tone Mode and then setting of the Tone Frequency. These actions are set up by using the Set (Menu) mode, selections #49 (SQL.TYP) and #52 (TN FRQ).**

1. Press and hold in the [MHz(SET)] key for one second, then rotate the DIAL knob to select “49 SQL.TYP”.
2. Press the [MHz(SET)] key, then rotate the DIAL knob so that “TONE” appears on the display; this activates the CTCSS Encoder, which allows repeater access.
3. Rotating the DIAL knob one more click clockwise in the above step will cause “TSQL” to appear. When “TSQL” appears, this means that the Tone Squelch system is active, which mutes your FT-2980R/E’s receiver until it receives a call from another radio sending out a matching CTCSS tone. This can help keep your radio quiet until a specific call is received, which may be helpful while operating in congested areas.

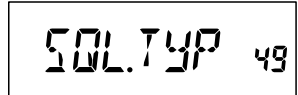

 **1) You may notice a “RV TN” indication on the display while you rotate the DIAL knob in this step; this means that the Reverse Tone Squelch system is active, which mutes your FT-2980R/E’s receiver (instead of opening the squelch) when it receives a call from the radio sending a matched CTCSS tone. The “T SQ” icon will blink on the display when the Reverse Tone Squelch system is activated.**

2) You may notice a “DCS” indication on the display while you rotate the DIAL knob still more. We’ll discuss the Digital Code Squelch system shortly.

4. When you have made your selection of the CTCSS tone mode, press the [MHz(SET)] key momentarily, then rotate the DIAL knob three clicks clockwise to select Menu “52 TN FRQ”. This Menu selection allows setting of the CTCSS tone frequency to be used.
5. Press the [MHz(SET)] key to enable adjustment of the CTCSS frequency.
6. Rotate the DIAL knob until the display indicates the Tone Frequency you need to be using.

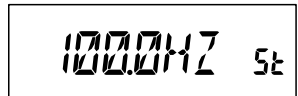
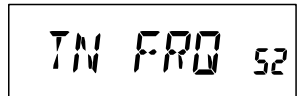

CTCSS TONE FREQUENCY (Hz)						
67.0	69.3	71.9	74.4	77.0	79.7	82.5
85.4	88.5	91.5	94.8	97.4	100.0	103.5
107.2	110.9	114.8	118.8	123.0	127.3	131.8
136.5	141.3	146.2	151.4	156.7	159.8	162.2
165.5	167.9	171.3	173.8	177.3	179.9	183.5
186.2	189.9	192.8	196.6	199.5	203.5	206.5
210.7	218.1	225.7	229.1	233.6	241.8	250.3
254.1	-	-	-	-	-	-

CTCSS/DCS/EPCS Operation

- When you have made your selection, press and hold in the [MHz(SET)] key for one second to save the new setting and exit to normal operation.



- 1) Your repeater may or may not re-transmit a CTCSS tone - some systems just use CTCSS to control access to the repeater, but don't pass it along when transmitting. If the S-Meter deflects, but the FT-2980R/E is not passing audio, repeat steps "1" through "3" above, but rotate the DIAL knob so that "TONE" appears - this will allow you to hear all traffic on the channel being received.**
- 2) You may use the Menu to re-program one of the Microphone's programmable keys for quick access to Menu #52 (TN FRQ), from which you can perform the above setup procedure. See the box on page 56 for setup details of the programmable keys.**
- 3) Press the [REV(DW)] key as described in procedure "6".**

You can now set the transmit CTCSS frequency. Rotate the DIAL knob until the desired CTCSS Tone Frequency is displayed. "tt" is displayed at the right of the CTCSS indication. When the [REV(DW)] key is pushed again "rt" is displayed along with the receive CTCSS frequency.
- 4) When the encoder and decoder tone frequencies are different, a solid decoder icon and a blinking encoder icon will be displayed.**

rt : Receive tone
tt : Transmit tone

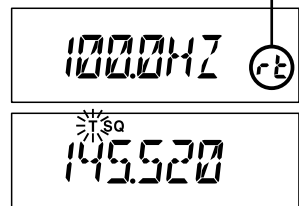

DCS Operation

Another form of tone access control is Digital Code Squelch, or DCS. It is a newer, more advanced tone system which generally provides more immunity from false paging than does CTCSS. The DCS Encoder/Decoder is built into your **FT-2980R/E**, and operation is very similar to that just described for CTCSS. Your repeater system may be configured for DCS; if not, it is frequently quite useful in Simplex operation if your friend(s) use transceivers equipped with this advanced feature.



Just as in CTCSS operation, DCS requires that you set the Tone Mode to DCS and that you select a Tone Code.

1. Press and hold in the **[MHz(SET)]** key for one second, then rotate the **DIAL** knob to select "49 SQL.TYP".
2. Press the **[MHz(SET)]** key, then rotate the **DIAL** knob until "DCS" appears on the display; this activates the DCS Encoder/Decoder.
3. Now press the **[MHz(SET)]** key momentarily, then rotate the **DIAL** knob to select Menu "14 DCS CD".
4. Press the **[MHz(SET)]** key momentarily to enable the adjustment of the DCS code.
5. Rotate the **DIAL** knob to select the desired DCS Code (a three-digit number).
6. When you have made your selection, press and hold in the **[MHz(SET)]** key for one second to save the new setting and exit to normal operation.

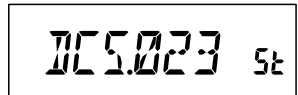
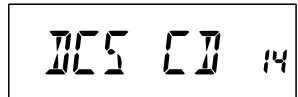
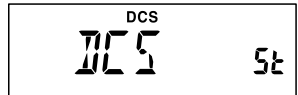
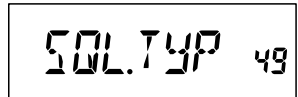

1) Remember that the DCS is an Encode/Decode system, so your receiver will remain muted until a matching DCS code is received on an incoming transmission. Switch the DCS off when you're just tuning around the band!

- 2) Press the **[REV(DW)]** key as described in procedure "6". You can now set the transmit DCS code. Rotate the **DIAL** knob until the desired DCS code is displayed. "tt" is displayed at the right of the DCS code indication. When the **[REV(DW)]** key is pushed again "rt" is displayed along with the receive DCS code.

rt : Receive DCS
tt : Transmit DCS

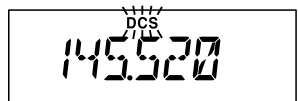
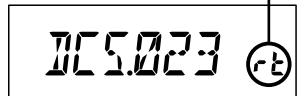

- 3) When the encoder and decoder DCS codes are different, a solid decoder icon and a blinking encoder icon will be displayed.

DCS CODE														
023	025	026	031	032	036	043	047	051	053	054	065	071	072	073
074	114	115	116	122	125	131	132	134	143	145	152	155	156	162
165	172	174	205	212	223	225	226	243	244	245	246	251	252	255
261	263	265	266	271	274	306	311	315	325	331	332	343	346	351
356	364	365	371	411	412	413	423	431	432	445	446	452	454	455
462	464	465	466	503	506	516	523	526	532	546	565	606	612	624
627	631	632	654	662	664	703	712	723	731	732	734	743	754	-

Tone Search Scanning

In operating situations where you don't know the CTCSS tone or DCS code being used by another station or stations, you can command the radio to listen to the incoming signal and scan in search of the tone being used. Two things must be remembered in this regard:

- You must be sure that your repeater uses the same tone type (CTCSS vs. DCS).
- Some repeaters do not pass the CTCSS tone or DCS code; you may have to listen to the station(s) transmitting on the repeater uplink (input) frequency in order to allow Tone Search Scanning to work.

To scan for the tone in use:

1. Set the radio up for either CTCSS or DCS Decoder operation (see the previous discussion). In the case of CTCSS, "TSG" will appear on the display; in the case of DCS, "DCS" will appear on the display.
2. Press the Microphone's [P3] key momentarily to start scanning for the incoming CTCSS or DCS tone/code.
3. When the radio detects the correct tone or code, it will halt on that tone/code, and audio will be allowed to pass.
4. Press the Microphone's [P3] key momentarily to lock in that tone/code and exit to normal operation.



105.023 St



100012 St

 **If the Tone Scan feature does not detect a tone or code, it will continue to scan indefinitely. When this happens, it may be that the other station is not sending any tone. You can press the Microphone's [P3] key to halt the scan at any time.**

You may listen to the (muted) signals from the other stations during Tone Scanning when Set Mode Item "54 TS MUT" is set to "OFF". See page 71 for details. You can also change the Tone Search scanning speed, using Set Mode Item "55 TS SPD". See page 71 for details.

Tone Scanning works either in the VFO or Memory mode.

EPCS (Enhanced Paging & Code Squelch) Operation

The FT-2980R/E includes an Enhanced CTCSS tone encoder/decoder and a dedicated microprocessor providing paging and selective calling features. This allows you to place a call to a specific station (Paging), and to receive calls of your choice directed only to you (Code Squelch).

The paging and code squelch systems use two pairs of (alternately switched) CTCSS tones which are stored in the pager memories. Basically, your receiver remains silent until it receives the CTCSS tone pair that matches those stored in the Receiving Pager Memory. The squelch then opens so the caller is heard, and the paging ringer immediately sounds, if activated. When you close the **PTT** switch to transmit, the CTCSS tone pair which is stored in the Transmitting Pager Memory will be transmitted automatically. On the paged radio, the squelch will close automatically after the incoming page ends.

Storing the CTCSS Tone Pairs for EPCS Operation

1. Press and hold in the **[MHz(SET)]** key for one second to enter the Set mode.
2. Rotate the **DIAL** knob to select “34 PAG.CDR” for the Receiving CTCSS Tone Pair or “35 PAG.CDT” for the Transmitting CTCSS Tone Pair.
3. Press the **[MHz(SET)]** key momentarily to enable adjustment of this Set Mode Item.
4. Rotate the **DIAL** knob to set the CTCSS Tone number which corresponds to the first tone of the CTCSS Tone Pair.
5. Press the **[REV(DW)]** or **[LOW(A/N)]** key, then rotate the **DIAL** knob to set the CTCSS Tone number which corresponds to the second tone of the CTCSS Tone Pair.
6. Press and hold in the **[MHz(SET)]** key for one second to lock in that tone/code and exit to normal operation.

PAG.CDR 34

PAG.CDT 35

*07 47 St

07*45 St



The FT-2980R/E does not recognize the order of the 1st tone and the 2nd tone. In other words, for

example, the FT-2980R/E considers both CTCSS pairs “10, 35” and “35, 10” to be identical.

CTCSS Tone Number

No.	Hz	No.	Hz	No.	Hz	No.	Hz	No.	Hz
01	67.0	11	94.8	21	131.8	31	171.3	41	203.5
02	69.3	12	97.4	22	136.5	32	173.8	42	206.5
03	71.9	13	100.0	23	141.3	33	177.3	43	210.7
04	74.4	14	103.5	24	146.2	34	179.9	44	218.1
05	77.0	15	107.2	25	151.4	35	183.5	45	225.7
06	79.7	16	110.9	26	156.7	36	186.2	46	229.1
07	82.5	17	114.8	27	159.8	37	189.9	47	233.6
08	85.4	18	118.8	28	162.2	38	192.8	48	241.8
09	88.5	19	123.0	29	165.5	39	196.6	49	250.3
10	91.5	20	127.3	30	167.9	40	199.5	50	254.1

CTCSS/DCS/EPCS Operation

Activating the Enhanced Paging & Code Squelch System

1. Press and hold in the **[MHz(SET)]** key for one second, then rotate the **DIAL** knob to select "32 PAGER".
2. Press the **[MHz(SET)]** key, then rotate the **DIAL** knob to set this Menu item to "ON".
3. Press and hold in the **[MHz(SET)]** key for one second to save the new setting and exit to normal operation.
4. To disable the Enhanced Paging & Code Squelch, just repeat the above procedure, rotating the **DIAL** knob to select "OFF" in step 2 above.



PAGER 32



ON 5t

When the Enhanced Paging & Code Squelch feature is activated, the "P" notation will appear by the 100 MHz digit of the frequency display.

Paging Answer Back

When you press the **PTT** switch to respond to a page call, the **FT-2980R/E** transmits the Transmitting CTCSS Tone pair. This tone pair will open the Code Squelch of the calling station. If you prefer, you can have the **FT-2980R/E** respond to page calls automatically ("transpond").

To enable this feature:

1. Press and hold in the **[MHz(SET)]** key for one second, then rotate the **DIAL** knob to select "33 PAG.ABK".
2. Press the **[MHz(SET)]** key, then rotate the **DIAL** knob to set this Menu item to "ON".
3. Press and hold in the **[MHz(SET)]** key for one second to save the new setting and exit to normal operation.
4. To disable the Paging Answer Back feature, just repeat the above procedure, rotating the **DIAL** knob to select "OFF" in step 2 above.



PAG.ABK 33



ON 5t

CTCSS/DCS/EPCS Bell Operation

During CTCSS Decode, DCS, or EPCS operation, you may set up the **FT-2980R/E** such that a ringing “bell” sound alerts you to the fact that a call is coming in. Here is the procedure for activating the CTCSS/DCS/EPCS Bell:

1. Set the transceiver up for CTCSS Decode (“Tone Squelch”), DCS, or EPCS operation, as described previously.
2. Adjust the operating frequency to the desired channel.
3. Press and hold in the **[MHz(SET)]** key for one second, then rotate the **DIAL** knob to select “7 BELL”.
4. Rotate the **DIAL** knob to set the desired number of rings of the Bell. The available choices are 1, 3, 5, or 8 rings, CNTNUE (continuous ringing), or OFF.
5. Press and hold in the **[MHz(SET)]** key for one second to save the new setting and exit to normal operation.



When you are called by a station whose transceiver is sending a CTCSS tone, DCS code, or CTCSS code pair which matches that set into your Decoder, the Bell will ring in accordance with this programming.

When the CTCSS/DCS/EPCS Bell is activated, the “🔔” icon will appear on the display.

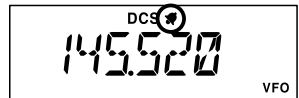

Split Tone Operation

The **FT-2980R/E** can be operated in a “Split Tone” configuration, to enable operation on repeaters using a mix of both CTCSS and DCS control via the Set mode.

1. Press and hold in the **[MHz(SET)]** key for one second, then rotate the **DIAL** knob to select “48 SPLIT”.
2. Press the **[MHz(SET)]** key, then rotate the **DIAL** knob to set this Menu item to “ON” (to enable the Split Tone feature).
3. Press and hold in the **[MHz(SET)]** key for one second to save the new setting and exit to normal operation.



When the Split Tone feature is activated, you can see the following additional parameters following the “RV TN” parameter (while selecting the tone mode by Set mode item “49 SQL. TYP”):

- D CODE: DCS Encode only (the “**DCS**” icon will blink during operation)
- T DCS: Encodes a CTCSS Tone and Decodes a DCS code (the “**T**” icon will blink and the “**DCS**” icon will appear during operation)
- D TONE: Encodes a DCS code and Decodes a CTCSS Tone (the “**T SQ**” icon will appear and “**DCS**” icons will blink during operation)

Select the desired operating mode from the selections shown above.

DTMF Operation

The Microphone's 16-button keypad allows easy DTMF dialing for Autopatch, repeater control, or Internet-link access purposes. Besides numerical digits [0] through [9], the keypad includes the [*] and [#] digits, plus the [A], [B], [C], and [D] tones often used for repeater control.

Manual DTMF Tone Generation

You can generate DTMF tones during transmission manually.

1. Press and hold in the [MHz(SET)] key for one second, then rotate the **DIAL** knob to select "17 DT A/M".
2. Press the [MHz(SET)] key, then rotate the **DIAL** knob to set this Set Mode Item to "MANUAL" (thus enabling the Manual DTMF Tone Generation).
3. Press and hold in the [MHz(SET)] key for one second to save the new setting and exit to normal operation.
4. Press the **PTT** switch to begin transmission.
5. While transmitting, press the desired numbers on the keypad.
6. When you have sent all the digits desired, release the **PTT** switch.



DT A/M 17



MANUAL dt

DTMF Autodialer

Nine DTMF Autodialer memories are available on the **FT-2980R/E**. These DTMF Autodialer memories can store up to 16 digits of a telephone number for repeater autopatch or other use.

To load DTMF Autodialer memories, use the following procedure:

1. Press and hold in the [MHz(SET)] key for one second, then rotate the **DIAL** knob to select "19 DT SET".
2. Press the [MHz(SET)] key, then rotate the **DIAL** knob to select the DTMF Autodialer memory channel number into which you wish store a telephone number ("C0" to "C9").
3. Press the [LOW(A/N)] key momentarily, then rotate the **DIAL** knob to select the first digit of the telephone number you wish to store.
4. When you have selected the correct digit, press the [LOW(A/N)] key momentarily. Now, rotate the **DIAL** knob to select the second of 16 available numbers in the current DTMF Autodialer memory register.
5. Repeat this procedure for each digit in the telephone number. If you a mistake, press the [REV(DW)] key to move back to the first digit, then re-enter the correct number.
6. Press and hold in the [LOW(A/N)] key for 2 seconds to delete all data after the cursor that may have been previously stored erroneously.
7. When entry of all digits is complete, press the [MHz(SET)] key.
8. If you wish to store another DTMF string, repeat steps 2 through 6 above.
9. Press and hold in the [MHz(SET)] key for one second to save the new setting and exit to normal operation.

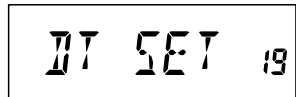

DT SET 19



C0

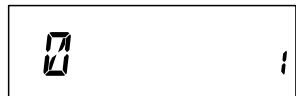

0 1

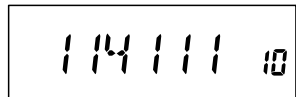

114111 10

To transmit the memorized telephone number, use the following procedure:

1. Press and hold in the **[MHz(SET)]** key for one second, then rotate the **DIAL** knob to select “17 DT A/M”.
2. Press the **[MHz(SET)]** key, then rotate the **DIAL** knob to set this Set Mode Item to “AUTO”.
3. Press and hold in the **[MHz(SET)]** key for one second to save the new setting and exit to normal operation.
4. In the Autodialer mode, which you just engaged, first press the **PTT** switch, then press the microphone’s numeric key (**[0]** through **[9]**) corresponding to the DTMF memory string you wish to send. Once the string begins, you may release the **PTT** switch, as the transmitter will be held “on the air” until the DTMF string is completed.



While the DTMF Autodialer is activated, the  icon will appear on the LCD.

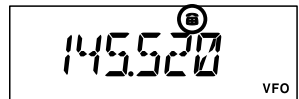

To disable the Autodialer function mode, select “MANUAL” in step 2 above.

The speed at which the DTMF digits are sent can be changed. Two speed levels are available: Low (10 digits per second) and High (20 digits per second: default). To toggle between Low and High speed, use the following procedure:

1. Press and hold in the **[MHz(SET)]** key for one second, then rotate the **DIAL** knob to select “20 DT SPD”.
2. Press the **[MHz(SET)]** key, then rotate the **DIAL** knob to select the desired speed (“50”: High speed or “100”: Low speed).
3. Press and hold in the **[MHz(SET)]** key for one second to save the new setting and exit to normal operation.

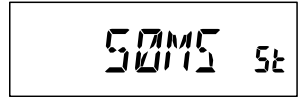

You can also set a longer delay between the time your transmitter is keyed and the first DTMF digit is sent. To set the delay time, use the following procedure:

1. Press and hold in the **[MHz(SET)]** key for one second, then rotate the **DIAL** knob to select “18 DT DLY”.
2. Press the **[MHz(SET)]** key, then rotate the **DIAL** knob to select the desired speed (50/250/450/750/1000 ms).
3. Press and hold in the **[MHz(SET)]** key for one second to save the new setting and exit to normal operation.

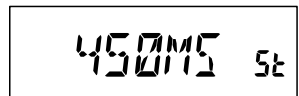
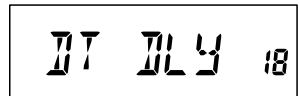

Memory Operation

The **FT-2980R/E** provides a wide variety of memory system resources. These include:

- ❑ 200 “basic” memory channels, numbered “0” through “199”.
- ❑ A “Home” channel, providing storage and quick recall of one prime frequency.
- ❑ 10 sets of band-edge memories, also known as “Programmable Memory Scan” channels, labeled “L0/U0” through “L9/U9”.
- ❑ 8 Memory Banks, labeled “BANK 1” through “BANK 8”. Each Memory Bank can be assigned up to 200 channels from the “basic” memory channels.

Each memory may be appended with an alpha-numeric label of up to six characters, for quick channel recognition.

Memory Storage

1. In the VFO mode, select the desired frequency, repeater shift, CTCSS/DCS tone, and TX power level.
2. Press and hold in the **[D/MR(MW)]** key for one second. A memory number will appear in the bottom right-hand corner of the display. If the channel number is blinking, there currently is no data stored on that channel; if the channel number is not blinking, that channel is currently “occupied” by other frequency data, and you won’t want to use that channel unless the data is no longer of interest.
3. Within five seconds of pressing the **[D/MR(MW)]** key, use the **DIAL** knob to select the desired memory into which you wish to store the frequency.
4. Press the **[D/MR(MW)]** key again, this time momentarily, to store the displayed data into the selected memory channel slot. The memory label will disappear (since you are still operating in the VFO mode).
5. To store other frequencies, repeat steps 1 through 4, remembering to set the repeater shift, CTCSS/DCS tone, and TX power level, as appropriate.

Storing Independent Transmit Frequencies (“Odd Splits”)

1. Store the receiving frequency using the method already described.
2. Tune to the desired transmit frequency, then press and hold in the **[D/MR(MW)]** key for one second.
3. Within five seconds of pressing the **[D/MR(MW)]** key, use the **DIAL** knob or microphone **[UP]/[DWN]** buttons to select the same memory channel number used in step 1 above.
4. Press and hold in the **PTT** switch, and press the **[D/MR(MW)]** key momentarily while holding in the **PTT** switch. This will not cause transmission, but rather it will instruct the transceiver that you are *programming* a separate *transmit* frequency into memory.

Whenever you recall a memory which contains independently stored transmit and receive frequencies, the “- +” indication will appear in the display.

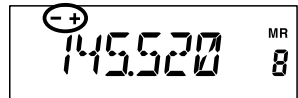

The “Odd Splits” feature can store separate CTCSS/DCS functions for the receive and transmit frequencies.

When you recall a memory channel which contains independently stored CTCSS/DCS information, the decoder icon will appear solid, and the encoder icon will blink on the display.

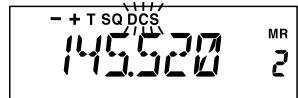

To confirm the memorized frequency/code:

1. Press and hold in the **[MHz(SET)]** key for one second to enter the Set mode.
2. Rotate the **DIAL** knob to select “14 DCS CD” when the receiver CTCSS/DCS function is set to “DCS”, or select “52 TN FRQ” when the receiver CTCSS/DCS function is set to “TONE SQUELCH”.
3. Press the **[MHz(SET)]** key momentarily to indicate the memorized frequency/code for the receiver.
4. Press the **[REV(DW)]** key to indicate the memorized frequency/code for the transmitter. You can confirm the Transmit and Receive TONE/DCS by alternately pressing of the **[REV(DW)]** key.

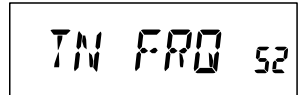
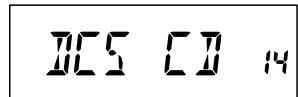

ⓁⓉ : Receive tone/DCS
ⓁⓉ : Transmit tone/DCS

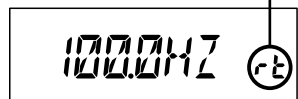

Memory Operation

Memory Recall

Once you have stored the memory or memories desired, you must now switch from the “VFO” mode to the “Memory Recall” mode, so you can operate on the just-stored memory channels.

1. Press the **[D/MR(MW)]** key, repeatedly if necessary, until the “**MR**” icon and a memory channel number appear on the display; this indicates that the “Memory Recall” mode is now engaged.



2. When more than one memory has been stored, use the **DIAL** knob to select any of the programmed memories for operation. Alternatively, the microphone's **[UP]** or **[DWN]** button may be used to step or scan through the available memories. When using the microphone's buttons, press the button momentarily to move one step up or down; press and hold in the **[UP]** or **[DWN]** button for one second to begin memory scanning.

Memory Recall from the Microphone's Keypad:

While operating in the Memory Recall mode, the keypad of the **MH-48A6J** Microphone may be used for direct recall of memory channels.

To do this, press the Channel Number you wish to recall, then press the **[#]** key. For example, to recall Memory Channel “5”, press **[5] → [#]**. To recall Memory Channel “118”, press **[1] → [1] → [8]**.

You may also recall Programmable Memory Scan (PMS) channels (“L0/U0” through “L9/U9”) using the following numbers: Programmable Memory channels #L0 = “200”, U0 = “201”, L9 = “218”, and U9 = “219”.

Labeling Memories

You may wish to append an alpha-numeric “Tag” (label) to a memory or memories, to aid in recollection of the channel’s use (such as club name, etc.). This is easily accomplished using the Set (Menu) mode.

1. Recall the memory channel on which you wish to append a label.
2. Press and hold in the [MHz(SET)] key for one second, then rotate the DIAL knob to select “30 NM SET”.
3. Press the [MHz(SET)] key. You will notice the first character location blinking, indicating that you are now in the Alpha-Numeric (“A/N”) entry mode. Within the A/N entry mode, rotate the DIAL knob to select *characters*; pressing the [LOW(A/N)] key will move the character’s *entry location* to the right.
4. Rotate the DIAL knob to select the desired number, letter, or symbol, then press the [LOW(A/N)] key to move the next character’s location. Press the [REV(DW)] key if you want to “backspace” one slot.
To enter a space, press the [LOW(A/N)] key to move one space to the right, and then rotate the DIAL knob to select the Blank (space).
Now press the [LOW(A/N)] key to enter the Blank (space). Press the [LOW(A/N)] key a second time to move to the next character location.
5. Repeat step 4, as necessary, to complete the name tag (up to six characters) for your memory, then press the [MHz(SET)] key momentarily to save the A/N name just entered.
6. Press and hold in the [MHz(SET)] key for one second to exit to normal operation.

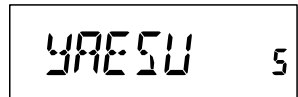
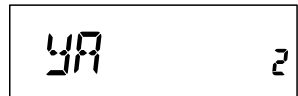
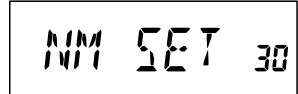

While operating in the Memory Recall mode, press and hold in the [LOW(A/N)] key for one second to toggle the display between indication of the frequency and the channel’s Alpha/Numeric label.

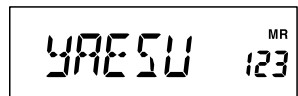
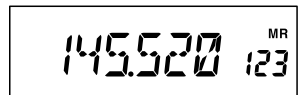

Memory Operation

Memory Tuning

Once you have recalled a particular memory channel, you may easily tune off that channel, as though you were in the VFO mode.

1. With the **FT-2980R/E** in the Memory Recall mode, select the desired memory channel.
2. Press the **[MHz(SET)]** key momentarily. The “MR” indicator will blink and the Memory Channel Number will disappear; these indicate that the “Memory Tuning” mode has been engaged.
3. Rotate the **DIAL** knob, or press the **[UP]** or **[DWN]** keys, to tune to a new frequency. The synthesizer steps you have selected for “VFO” operation will be the steps used during Memory Tuning.
4. If you wish to return to the original memory frequency, press the **[D/MR(MW)]** key momentarily. The “MR” indicator will stop blinking and the Memory Channel Number will reappear.
5. If you wish to store into memory a new frequency set during Memory Tuning, just press and hold in the **[D/MR(MW)]** key for one second, then complete the normal memory storage procedure. Be sure to select an open memory channel when doing so.

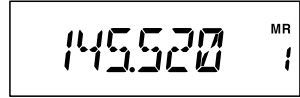

145.520 MR 1



145.520 MR



144.280 MR

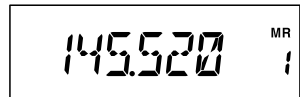

145.520 MR 1

Masking Memories

There may be situations where you want to “Mask” memories so they are not visible during memory selection or scanning. For example, several memories used only in a city you visit infrequently may be stored, then “Masked” until you visit that city, at which time you can “Unmask” them for normal use. (except for Memory Channel “0”, the Priority Channel, and the Home Channel).

1. With the **FT-2980R/E** in the Memory Recall mode, press and hold in the **[D/MR(MW)]** key for one second, then rotate the **DIAL** knob to select the memory channel you wish to delete.
2. Press the **[LOW(A/N)]** key momentarily. The display will revert to memory channel “0”. The previously-selected memory will be “masked”.
3. To Unmask a hidden memory, repeat the above procedure: press and hold in the **[D/MR(MW)]** key for one second, rotate the **DIAL** to select the masked memory’s number, then press the **[LOW(A/N)]** key to restore the memory channel’s data.



You can manually store data over a “Masked” memory, deleting previous data, if you’re not careful. Use the “next available memory” technique (look for the blinking memory channel number) storage technique to avoid over-writing a masked memory.

Memory Bank Operation

The large number of memories available in the **FT-2980R/E** could be difficult to utilize without some means of organizing them. Fortunately, the **FT-2980R/E** includes provision for dividing the memories into as many as eight Memory Banks, so you can categorize the memories in a manner convenient to you. You may enter and exit the “Memory Bank” mode by a single press of the Microphone’s [*] key, as we shall see below.

Assigning Memories to a Memory Bank

1. Recall the memory channel to be assigned to a Memory Bank.
2. Press and hold in the [D/MR(MW)] key for one second, then rotate the **DIAL** knob to select the Memory Bank number (“b1” ~ “b8”) you want as the Memory Bank for this channel. The Memory Bank numbers are found by rotating the **DIAL** knob counter-clockwise past memory channel “0”.
3. Press the [D/MR(MW)] key momentarily to copy the memory channel data into the Memory Bank.



145.520 MR 5

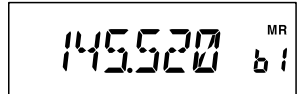

145.520 MR b1



1) You may assign one memory channel into several Memory Banks.

2) The PMS memory channels (L0/U0 through L9/U9) may not be assigned to a Memory Bank.

Memory Bank Recall

1. Press the [D/MR(MW)] key, if needed, to enter the Memory mode.
2. Press the Microphone’s [*] key to activate the “Memory Bank” mode. The Memory Bank number will appear on the display.
3. Press the [#] key to increment the Memory Bank (“b1” through “b8”).
4. Rotate the **DIAL** knob to select the memories within the selected Bank; you will observe that you can only select memory channels in the current memory bank. The small memory bank number will appear, to the right of the frequency display, two seconds after you complete memory channel selection while operating within a Memory Bank.
5. To change to another Memory Bank, press the [#] key to step up to the next-highest bank.
6. To exit from Memory Bank operation, just press the Microphone’s [*] key. The Memory Channel number will appear steadily on the right side of the display, indicating that you are now in the “standard” Memory Recall mode, without utilization of the Memory Banks. The memories stored in the various Banks will remain in those banks, however; you do not need to store them again.

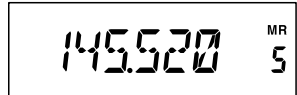

145.520 MR 5

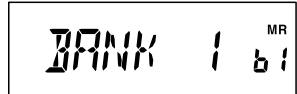

BANK 1 MR b1

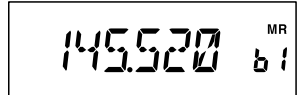

145.520 MR b1



145.560 MR b2



145.640 MR b3



145.520 MR 5

Memory Operation

Removing Memories from a Memory Bank

1. While operating in the Memory Bank mode, recall the memory channel to be removed from a Memory Bank.
2. Press and hold in the [D/MR(MW)] key for one second, then press the [A/N(LOW)] key to remove the memory channel data from the Memory Bank.

 **You must first enter the Memory Bank mode, by pressing the microphone's [*] key, before attempting to remove a channel from a Bank. If you don't, "MCHERR" will appear when you press the [A/N(LOW)] key in step (2) above.**



MCHERR

Changing a Memory Bank's Name

You may change the default Memory Bank Name, which is indicated on the display when you've selected a Memory Bank, to a different name, if desired.

1. Press and hold in the [MHz(SET)] key for one second, then rotate the **DIAL** knob to select "9 BNK NM".
2. Press the [MHz(SET)] key momentarily, then rotate the **DIAL** knob to recall the memory bank on which you wish to change a label.
3. Press the [A/N(LOW)] key to enable changing of the name tag.
4. Rotate the **DIAL** knob to select the first digit of the desired label.
5. Press the [A/N(LOW)] key to move to the next character.
6. If you make a mistake, press the [REV(DW)] key to back-space the cursor, then re-enter the correct letter, number, or symbol.
7. Repeat steps 4 through 6 to program the remaining letters, numbers, or symbols of the desired label. A total of six characters may be used in the creation of a label.
8. When you have programmed a name which is under 6 characters, press and hold in the [MHz(SET)] key for one second to confirm the label and exit to normal operation.



BNK NM 9



BANK 1 b 1



2BANK 1 1



2M HAM 6

Home Channel Memory

A convenient one-touch “Home” channel memory is available to simplify return to your most-often-used frequency. This memory does not appear in the regular memory bank, to simplify operation and speed recall of this important channel.

To recall the Home channel, just press the **[D/MR(MW)]** key, repeatedly if necessary, until the “**HM**” icon appears on the display; this indicates that the Home Channel has been recalled.

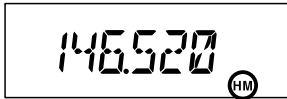

USA version



Asian/European version

The factory default frequency for the Home channel is 146.520 MHz (USA version) or 144.000 MHz (Asian and European version). You can re-program the Home channel in a manner identical to that used for the regular memories:

1. From the VFO mode, tune in the frequency you wish to store, and set all repeater shifts and other data just the way you do for “normal” memory channel storage.
2. Press and hold in the **[D/MR(MW)]** key for one second, then press the **[REV(DW)]** key to store the displayed data into the Home channel. The memory label will disappear (since you are still operating in the VFO mode).

You may also append an alpha-numeric “Tag” (label) to a Home channel, as described previously. be sure to recall the Home channel first, then enter the Menu (selection “30 NM SET”) to program the label’s contents.

From the Home channel, you may tune off (as in the Memory Tune mode) without doing anything more than rotating the main DIAL knob. This automatically shifts control to the VFO, making it a good idea to program in your area’s “Calling Frequency” as the Home channel. Once contact is established, you may then tune off the Calling Frequency to an open simplex frequency to carry on your QSO.

Memory-Only Mode

Once memory channel programming has been completed, you may place the radio in a “Memory Only” mode, whereby VFO and Home Channel operation are impossible. This may be particularly useful during public-service events where a number of operators may be using the radio for first time, and ultimate simplicity of channel selection is desired.

To place the radio into the Memory Only mode, turn it off. Now press and hold in the **[D/MR(MW)]** key while turning the radio on. The VFO and Home Channel will now be disabled.

To return to normal operation, repeat the above power-on procedure.

Scanning

The **FT-2980R/E**'s scanning capability provides the operator with many convenient methods of rapid frequency navigation.

Basic Scanner Operation

Before activating the scanner, make sure that the Squelch is set to silence the background noise when no signal is present. Scanning is not possible while the Squelch is open (if noise or signals are being heard).

Scanning may be started or stopped using the microphone's **[UP]** or **[DWN]** button. The following techniques are used for scanning:

- Pressing and holding in either the **[UP]** or **[DWN]** button for one second in the *VFO mode* will cause upward or downward *band* scanning, respectively, to begin.
- Pressing and holding in either the **[UP]** or **[DWN]** button for one second in the *Memory mode* will cause memory channel scanning toward a higher- or lower-numbered *memory channel*, respectively.
- Scanning pauses when a signal opens the squelch, and the decimal point on the display will blink. You can choose one of three scan-resume modes (described later).
- To halt the scan manually, the easiest way is to push the **PTT** switch on the microphone momentarily (no transmission will occur while you are scanning). The scan may also be halted manually by pressing the microphone's **[UP]** or **[DWN]** button, or the **[D/MR(MW)]** key.

 In the factory default setting, the scanner sweeps all frequencies while the *VFO mode* and all memory channels while the *Memory mode*. You may change the sweep range of the *VFO mode* to ± 1 MHz, ± 2 MHz, or ± 5 MHz, or sweep only those Memory Channels with the same “first” or “first” and “second” digits of the alpha/numeric tag as the first channel on which scanning started, using Set Mode items “28 MEM.SCN” and “56 VFO.SCN”. See pages 67 and 71 for details.

Scan-Resume Options

Three scan-resume modes are available on the **FT-2980R/E**:

- ❑ In the “BUSY” mode, the scanner will remain halted for as long as there is carrier present on the channel; after the carrier drops at the end of the other station’s transmission, scanning will resume.
- ❑ In the “HOLD” mode, the scanner will halt on a signal it encounters. It will not restart automatically; you must manually re-initiate scanning if you wish to resume.
- ❑ In the “3SEC/5SEC/10SEC” mode, the scanner will halt for the selected resume time, after which scanning will resume (whether or not the other station is still transmitting).

The default scan-stop mode is “BUSY”. To change the scan-resume mode, use the following procedure:

1. Press and hold in the **[MHz(SET)]** key for one second, then rotate the **DIAL** knob to select “41 RESUME”.
2. Press the **[MHz(SET)]** key, then rotate the **DIAL** knob to select the desired scan-resume mode.
3. Press and hold in the **[MHz(SET)]** key for one second to save the new setting and exit to normal operation.

RESUME 41

BUSY 5t

Memory Skip Scanning

When you have some continuously-active channels in memories, you may wish to *skip* them for *scanning*, but still have them available for *manual selection*.

To mask a memory to be skipped (only) during scanning, use the following procedure:

1. Set the radio to the Memory Recall mode by pressing the **[D/MR(MW)]** key repeatedly, as necessary, until “MR” and a channel number appear on the right side of the display.
2. Rotate the **DIAL** knob to select the Memory Channel to be skipped during scanning.
3. Press and hold in the **[MHz(SET)]** key for one second, then rotate the **DIAL** knob to select “47 SKIP”.
4. Press the **[MHz(SET)]** key, then rotate the **DIAL** knob so as to select “SKIP”. The current Memory Channel will now be ignored during scanning. The “ONLY” selection is used for “Preferential Memory Scan”, described in the next section.
5. Press and hold in the **[MHz(SET)]** key for one second to save the new setting and exit to normal operation.

145.520 MR 15

SKIP 47

SKIP 5t

A “SKIP” icon will appear when you recall the “skipped” memory channel manually.

To re-institute a channel into the scanning loop, select “OFF” in step 4 above, after first recalling the currently-blocked channel (the “Skipped” channel is accessible via manual channel selection methods using the **DIAL** knob in the Memory mode, whether or not it is locked out of the scanning loop).

145.520 SKIP MR 15

Preferential Memory Scan

The **FT-2980R/E** also allows you to set up a “Preferential Scan List” of channels which you can “flag” within the memory system. These channels are designated by a blinking “**SKIP**” icon when you have selected them, one by one, for the Preferential Scan List.

When you initiate memory scanning, *beginning on a channel with the Blinking “**SKIP**” icon appended*, only those channels bearing the Blinking “**SKIP**” icon will be scanned. If you initiate scanning on a channel which does not have the Blinking “**SKIP**” icon appended, you will scan all channels *including* those with the Blinking “**SKIP**” icon appended.

Here is the procedure for setting up and using the Preferential Scan List:

1. Set the radio to the Memory Recall mode by pressing the **[D/MR(MW)]** key repeatedly, if necessary.
2. Rotate the **DIAL** knob to select the Memory Channel which you wish to add to the Preferential Scan List.
3. Press and hold in the **[MHz(SET)]** key for one second, then rotate the **DIAL** knob to select “47 SKIP”.
4. Press the **[MHz(SET)]** key, then rotate the **DIAL** knob so as to select “ONLY”.
5. Press and hold in the **[MHz(SET)]** key for one second to save the new setting and exit to normal operation.

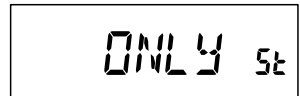
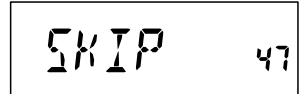

To initiate Preferential Memory Scanning:

1. Set the radio to the Memory Recall mode by pressing the **[D/MR(MW)]** key repeatedly, if necessary.
2. Rotate the **DIAL** knob to select any memory channel which has a blinking “**SKIP**” icon appended to the channel number.
3. Press and hold in either the microphone’s **[UP]** or **[DWN]** button for one second to initiate Preferential Memory Scanning. Only the channels which have a blinking “**SKIP**” icon appended to the channel number will be scanned.

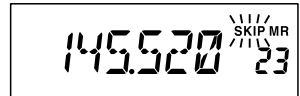

Memory Bank Link Scan

When the Memory Bank feature is engaged, the scanner sweeps only memory channels in the current Memory Bank. However, if the Memory Bank Link Scan feature is enabled, you may sweep the memory channels in several Memory Banks which you have selected.

To enable the Memory Bank Link Scan feature:

1. Set the radio to the Memory mode by pressing the **[D/MR(MW)]** key, if necessary.
2. Press and hold in the **[MHz(SET)]** key for one second, then rotate the **DIAL** knob to select "8 BNK.LNK".
3. Press the **[MHz(SET)]** key momentarily, then rotate the **DIAL** knob to select the first Memory Bank ("b1" ~ "b8") you wish to sweep using Memory Bank Link Scan.
4. Press the **[D/MR(MW)]** key momentarily. A "SKIP" icon will blink above the Memory Bank number, indicating this Memory Bank will now be swept during Memory Bank Scan.
5. Repeat steps 3 and 4 above, to append the blinking "SKIP" icon to any other Memory Banks you wish to sweep.
6. Now, press and hold in the **[MHz(SET)]** key for one second to initiate the Memory Bank Link Scan.
7. To remove a Memory Bank from the Memory Bank Link Scan, repeat steps 2 - 4 above, to delete the blinking "SKIP" icon from the Memory Bank number indication.

The LCD display shows the text "BNK.LNK" followed by the number "8".

The LCD display shows the text "BNK" followed by the number "1" and the letter "b1".

The LCD display shows the text "BNK" followed by the number "1" and the letter "b1". A small circle containing the word "SKIP" is positioned above the number "1".

The LCD display shows the text "BNK" followed by the number "3" and the letter "b3". A small circle containing the word "SKIP" is positioned above the number "3".

Programmable Band-Scan Limits

Besides band and memory scanning, this transceiver can be set to tune or scan only the frequencies between user-defined lower and upper limits. For example, you may wish to limit tuning/scanning to 144.3 - 148.0 MHz, to avoid encroachment on the SSB/CW sub-band between 144.0 and 144.3 MHz.

These scanning limits are stored in special "Sub-Band Limit Memories", labeled LO/UO through L9/U9, with "L" and "U" designations representing the Lower and Upper limits, respectively.

To utilize this feature, use the following steps:

1. Store the lower edge of the desired scanning/tuning range in memory "LO", and the upper edge in memory "UO" (or, alternatively, in memories "L1/U1" through "L9/U9").
2. With any of these memories recalled, press the **[MHz(SET)]** key momentarily to activate the Programmable Band-Scan Limits. The "PMS" icon will appear. Tuning and scanning will now be limited within the just-programmed range.

To cancel the Sub-Band Limits and return to normal memory operation, press the **[D/MR(MW)]** key momentarily.



Do not attempt to initiate "normal" scanning on any of the PMS memory channels. If you do, an error message will result; the "U/L" memories are dedicated for the establishment of band scanning limits.

Priority Channel Scanning (Dual Watch)

The **FT-2980R/E**'s scanning features include a two-channel scanning capability which allows you to operate on a VFO, Memory channel, or Home channel, while periodically checking a user-defined Memory Channel for activity. If a station is received on the Memory Channel which is strong enough to open the Squelch, the scanner will pause on that station in accordance with the Scan-Resume mode set via Menu item "41 RESUME". See page 39.

Here is the procedure for activating Priority Channel Dual Watch operation:

1. Set the radio to the Memory Recall mode by pressing the **[D/MR(MW)]** key repeatedly, if necessary.
2. Press and hold in the **[D/MR(MW)]** key for one second (the Memory Channel number will blink), then select the memory channel you wish to be the "Priority" channel.
3. Press the **[X]** key momentarily. The "**PRI**" icon will appear to the upper right corner on the display; indicating it is the Priority channel.
4. Now set the **FT-2980R/E** for operation on another memory channel, Home channel, or on a VFO frequency.
5. Press and hold in the **[REV(DW)]** key for one second. The display will remain on the VFO, the selected memory channel, or the Home channel, but every five seconds the **FT-2980R/E** will check the Priority Channel for activity.
6. To cancel Dual Watch operation, press the **[D/MR(MW)]** key momentarily.

Priority Revert Mode

During Priority channel operation (Dual Watch), a special feature is available which will allow you to move to the Priority Channel instantly, without waiting for activity to appear on the Priority Channel.

When this feature is enabled, and priority monitoring is engaged, just press the microphone's **PTT** switch. Operation will instantly revert to the Priority Channel.

To enable Priority Revert operation:

1. Press and hold the **[MHz(SET)]** key for one second, then rotate the **DIAL** knob to select "44 RVRT".
2. Press the **[MHz(SET)]** key, then rotate the **DIAL** knob to select "ON".
3. Press and hold the **[MHz(SET)]** key for one second to save the new setting and exit to normal operation.



To disable Priority Revert operation, select "OFF" in step 2 above.

Weather Alert Scan

This feature allows you to check the Weather Broadcast Memory Channels for the presence of the NOAA Alert Tone while operating using VFO scan or Memory channel scan.

When the Weather Alert Scan feature is engaged, the **FT-2980R/E** will check the Weather Broadcast Memory Channels for activity every five seconds while scanning. If you watch the display carefully, you'll observe the scanner periodically shifting to the Weather Broadcast bank, scanning the Weather channels quickly in search of the Alert Tone, after which regular scanning will resume for another five seconds.

To enable the Weather Alert Scan feature:

1. Press and hold in the **[MHz(SET)]** key for one second, then rotate the **DIAL** knob to select "57 WX ALT".
2. Press the **[MHz(SET)]** key, then rotate the **DIAL** knob to set this Menu item to "ON".
3. Press and hold in the **[MHz(SET)]** key for one second to save the new setting and exit to normal operation.
4. To disable the Weather Alert Scan feature, select "OFF" in step 2 above.



WX ALT 57



ON 57

You can change the Weather Alert Tone volume level to maximum regardless the **VOL** knob setting, using Menu item "58 WX VOL". See page 71 for details.



1) When the Weather Alert Scan feature is engaged, the Scan-Resume mode will be fixed on "HOLD".

2) If you are just scanning the Weather Broadcast Channels, the FT-2980R/E's receiver will remain muted indefinitely unless the Alert Tone is received. This yields a long period of monitoring time, as no power will be consumed via audio output while scanning (for the Alert Tone) is in progress.

Band Edge Beeper

The **FT-2980R/E** will automatically "beep" when the receiver's band edge is encountered during scanning (either in standard VFO scanning or during PMS operation). You may additionally enable this feature (band edge beeper) when the frequency reaches the band edge while selecting the VFO frequency manually, using the **DIAL** knob.

The procedure for enabling the Band-Edge Beeper (during manual tuning) is:

1. Press and hold in the **[MHz(SET)]** key for one second, then rotate the **DIAL** knob to select "21 EDG.BEP".
2. Press the **[MHz(SET)]** key, then rotate the **DIAL** knob to set this Menu item to "ON".
3. Press and hold in the **[MHz(SET)]** key for one second to save the new setting and exit to normal operation.



EDG.BEP 21



ON 57

Smart Search Operation

The Smart Search feature allows you to load frequencies automatically according to where activity is encountered by your radio. When Smart Search is engaged, the transceiver will search above and below your current frequency, storing active frequencies as it goes (without stopping on them even momentarily); these frequencies are stored into a special Smart Search memory band, consisting of 31 memories (15 above the current frequency, 15 below the current frequency, plus the current frequency itself).

Two basic operating modes for Smart Search are available:

SINGLE: In this mode, the transceiver will sweep the current band once in each direction, starting on the current frequency. All channels where activity is present will be loaded into the Smart Search memories; whether or not all 31 memories are filled, the search will stop after one sweep in each direction.

CNTNUE (Continue): In this mode, the transceiver will make one pass in each direction, as with “SINGLE” searching; if all 31 channels are not filled after the first sweep, however, the radio will continue sweeping until they are all filled.

Setting the Smart Search Mode

1. Press and hold in the **[MHz(SET)]** key for one second, then rotate the **DIAL** knob to select “45 S SRCH”.
2. Press the **[MHz(SET)]** key, then rotate the **DIAL** knob to select the desired Smart Search mode (see above).
3. Press and hold in the **[MHz(SET)]** key for one second to save the new setting and exit to normal operation.



5 SRCH 45



CNTNUE 5t

Storing Smart Search Memories

1. Set the radio to the VFO mode. Be sure that you have the Squelch adjusted properly (so that band noise is quieted).
2. Press the Microphone's **[P2]** key to enter the Smart Search mode. The “S SRCH” notation will appear on the display for two seconds.
3. Press the **[MHz(SET)]** key (or Microphone's **[A]** key) to begin Smart Search scanning.
4. As active channels are detected, they will automatically be stored into the Smart Search memory bank without causing the sweep to halt.
5. Depending on the mode you set for Smart Search operation (“SINGLE” or “CNTNUE”), the Smart Search scan will eventually terminate, and the LCD will revert to Smart Search Memory Channel “C”.
6. To recall the Smart Search memories, just rotate the **DIAL** knob to choose from among the Smart Search memories.
7. To return to normal operation, press the **[D/MR(MW)]** key.



5 SRCH





Smart Search is a great tool when visiting a city for the first time. You don't need to spend hours looking up repeater frequencies from a reference guidebook; just ask your FT-2980R/E where the action is!

Internet Connection Feature

The **FT-2980R/E** can be used to access a “node” (repeater or base station) which is tied into the Yaesu **WIRES™** (Wide-Coverage Internet Repeater Enhancement System) network. Details may be found at the **WIRES-II** Web site: <http://www.yaesu.com/jp/en/wiresinfo-en/index.html>. This feature may also be used to access other systems, as described below.

SRG (“Sister Radio Group”) Mode

1. Press the [**☒**] key momentarily to activate the Internet Connection feature. The “**Int**” notation will appear at the right of the frequency. 
2. Rotate the **DIAL** knob while pressing the [**☒**] key to select the access number (DTMF “0” ~ “9”, “A”, “B”, “C”, “D”, “E (*), “F (#)”) corresponding to the **WIRES™** node to which you wish to establish an Internet link (ask the node or repeater owner/operator if you don’t know the access number in the network). Now press the **PTT** switch to exit from the selection mode. 
3. With the Internet Connection feature activated (as in step 1 above), the **FT-2980R/E** will generate a brief (0.1 second) DTMF tone according to your selection in step 2. This DTMF tone is sent at the beginning of every transmission to establish or maintain the link to the local **WIRES™** node operating in the SRG mode.
4. To disable the Internet Connection feature, press the [**☒**] key momentarily (the “**Int**” notation will disappear from the display).



If other users report that you always have a DTMF “beep” at the beginning of each transmission, and you are not operating in conjunction with Internet access, disable this function via step (4) above.



FRG (“Friends’ Radio Group”) Mode

You may access other Internet Link Systems (including **WIRES™** in the “FRG” mode) that use a DTMF string for access.





Programming the FRG code

Load the DTMF tones which you wish to use for Internet-link access into a Internet Memory register. For purposes of this example, we will use “#(F)1101D” as the access code (the “#” key is denoted by the letter “F”).



1. Press and hold in the [**MHz(SET)**] key for one second, then rotate the **DIAL** knob to select “25 INT.SET”.
2. Press the [**MHz(SET)**] key, then rotate the **DIAL** knob to select the Internet Memory register (F0 ~ F9) into which you wish to store the access code.
3. Press the [**LOW(A/N)**] key momentarily. The first digit will blink.

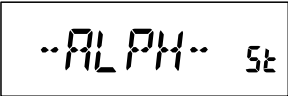

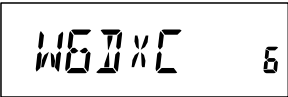
Internet Connection Feature

- Rotate the **DIAL** knob to select “F” (representing DTMF “#”: the first digit of the DTMF string). 
- Press the **[LOW(A/N)]** key momentarily to accept the first digit and move to the second digit of the DTMF string.
- Repeat the previous steps until you have completed the access code (“#(F)1101D”). 
- If you wish to attach an alpha/numeric name “Tag” to the Internet Memory, proceed to the next step; otherwise press and hold in the **[MHz(SET)]** key for one second to save the setting.
- Press the **[MHz(SET)]** key twice to enable programming of the name tag (the Internet Memory register number will blink). 
- Press the **[D/MR(MW)]** key momentarily. The “--ALPHA--” notation will appear on the display for 2 seconds, then the Memory register number will blink again.
- Press the **[MHz(SET)]** key momentarily. The first digit will blink.
- Rotate the **DIAL** knob to select the first digit of the desired label. 
- Press the **[LOW(A/N)]** key to move to the next character.
- If you make a mistake, press the **[REV(DW)]** key to back-space the cursor, then re-enter the correct letter, number, or symbol.
- Repeat steps 11 and 12 to program the remaining letters, numbers, or symbols of the desired label. A total of six characters may be used in the creation of a label. 
- When you have finished programming the label (6 characters or less), press and hold in the **[MHz(SET)]** key for one second to confirm the label.
- Repeat steps 1 through 15 to store other access codes, if so desired.
- Press the **PTT** switch to save the setting and exit to normal operation.

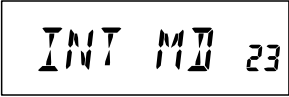
Operation (Accessing an FRG Node)

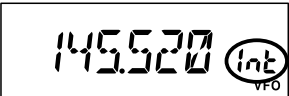
- Press and hold in the **[MHz(SET)]** key for one second, then rotate the **DIAL** knob to select “23 INT MD”. 
- Press the **[MHz(SET)]** key, then rotate the **DIAL** knob to set this Set Mode Item to “FRG” (thus activating the “Other Internet Link System” mode). 
- Press and hold in the **[MHz(SET)]** key for one second to save the new setting.
- Press the **[⊗]** key momentarily to activate the Internet Connection feature. The “Int” notation will appear at the right of the frequency. 

Internet Connection Feature

5. Rotate the **DIAL** knob while pressing the [✖] key to select the Internet Memory register number (F0 ~ F9) (or Name) corresponding to the Internet link repeater to which you wish to establish an Internet link, then press the **PTT** switch momentarily to lock in the selected access number.
6. Once the Internet Connection feature is activated per step 4 above, you may now press the [✖] key, while you are transmitting, to send out the selected DTMF string (to establish the link to the desired Internet-link mode).
7. To return to the WiRES™ mode, repeat steps 1 - 3 above, selecting "SRG" in step 2.

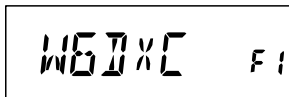

ARTS™ (Automatic Range Transponder System)

The ARTS™ feature uses DCS signaling to inform both parties when you and another ARTS™-equipped station are within communications range. This may be particularly useful during Search-and Rescue situations, where it is important to stay in contact with other members of your group.

Both stations must set up their DCS codes to the same code number, then activate their ARTS™ feature using the command appropriate for their radio. Alert ringers may be activated, if desired.

Whenever you push the **PTT** switch, or every 25 (or 15) seconds after ARTS™ is activated, your radio will transmit a signal which includes a (subaudible) DCS signal for about 1 second. If the other radio is in range, the beeper will sound (if enabled) and the display will show “IN RNG” as opposed to the out of range display “OUTRNG” in which ARTS™ operation begins.

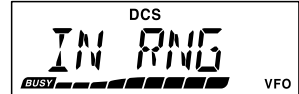

Whether you talk or not, the polling every 15 or 25 seconds will continue until you deactivate ARTS™. Every 10 minutes, moreover, you can have your radio transmit your callsign via CW, so as to comply with identification requirements. When ARTS™ is de-activated, DCS will also be deactivated (if you were not using it previously in non-ARTS™ operation).

If you move out of range for more than one minute (four pollings), your radio will sense that no signal has been received, three beeps will sound, and the display will revert to “OUTRNG”. If you move back into range, your radio will again beep, and the display will change back to the “IN RNG” indication.

During ARTS™ operation, your operating frequency will continue to be displayed, but no changes may be made to it or other settings; you must terminate ARTS™ in order to resume normal operation. This is a safety feature designed to prevent accidental loss of contact due to channel change, etc.

Basic ARTS™ Setup and Operation

1. Assign the ARTS™ feature to the microphone's programmable button ([P1], [P2], [P3], or [P4]), per the discussion on page 56.
2. Set your radio and the other radio(s) to the same DCS code number, per the discussion on page 23.
3. Press the assigned microphone's programmable button momentarily. You will observe the “OUTRNG” display on the LCD. ARTS™ operation has now commenced.
4. Every 25 seconds, your radio will transmit a “polling” call to the other station. When that station responds with its own ARTS™ polling signal, the display will change to “IN RNG” to confirm that the other station's polling code was received in response to yours.
5. Press the assigned microphone's programmable button momentarily to exit ARTS™ operation and resume normal functioning of the transceiver.

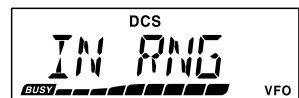
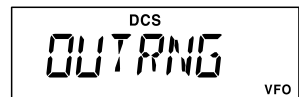

ARTS™ (Automatic Range Transponder System)

ARTS™ Polling Time Options

The ARTS™ feature may be programmed to poll every 25 seconds (default value) or 15 seconds. The default value provides maximum battery conservation, because the polling signal is sent out less frequently. To change the polling interval:

1. Press and hold in the **[MHz(SET)]** key for one second, then rotate the **DIAL** knob to select "3 AR INT".
2. Press the **[MHz(SET)]** key, then rotate the **DIAL** knob to select the desired polling interval (15 or 25 seconds).
3. When you have made your selection, press and hold in the **[MHz(SET)]** key for one second to save the new setting and exit to normal operation.

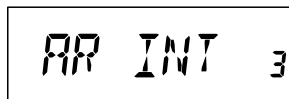

AR INT 3

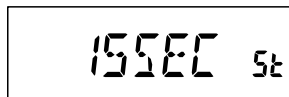

15SEC St

ARTS™ Alert Beep Options

The ARTS™ feature allows two kinds of alert beeps (with the additional option of turning them off), so as to alert you to the current status of ARTS™ operation. Depending on your location and the potential annoyance associated with frequent beeps, you may choose the Beep mode which best suits your needs. The choices are:

- IN RNG: The beeps are issued only when the radio first confirms that you are within range, but does not re-confirm with beeps thereafter.
- ALWAYS: Every time a polling transmission is received from the other station, the alert beeps will be heard.
- OFF: No alert beeps will be heard; you must look at the display to confirm current ARTS™ status.

To set the ARTS™ Beep mode, use the following procedure:

1. Press and hold in the **[MHz(SET)]** key for one second, then rotate the **DIAL** knob to select "2 AR BEP".
2. Press the **[MHz(SET)]** key, then rotate the **DIAL** knob to select the desired ARTS™ Beep mode (see above).
3. When you have made your selection, press and hold in the **[MHz(SET)]** key for one second to save the new setting and exit to normal operation.

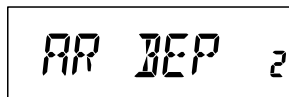

AR BEP 2

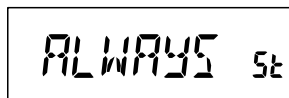





ALWAYS St

ARTS™ (Automatic Range Transponder System)

CW Identifier Setup

The ARTS™ feature includes a CW identifier, as discussed previously. Every ten minutes during ARTS™ operation, the radio can be instructed to send “DE (your callsign) K”, if this feature is enabled. The callsign field may contain up to 16 characters.

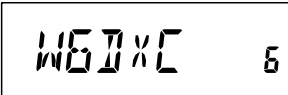
Here’s how to program the CW Identifier:

1. Press and hold in the **[MHz(SET)]** key for one second, then rotate the **DIAL** knob to select “11 CW ID”. 
2. Press the **[MHz(SET)]** key, followed by the **[LOW(A/N)]** key, to display any previously-stored callsign. 
3. Press and hold in the **[LOW(A/N)]** key for one second to Clear any previous callsign. 
4. Rotate the **DIAL** knob to select the first letter/number of your callsign, then press the **[LOW(A/N)]** key momentarily to save the first letter/number and move on to the next character. 
5. Repeat the previous step, as many times as necessary, to complete your callsign. Note that the “slant bar” (– • • – •) is among the available characters, should you be a “portable” station.
6. If you make a mistake, press the **[REV(DW)]** key to move back to the previous letter/number’s slot, then re-select the correct letter/number.
7. When you have finished entering your entire callsign and it contains less than 16 characters, press the **[MHz(SET)]** key momentarily to confirm the callsign. (if you callsign has exactly 16 characters, you do not need to press the **[MHz(SET)]** key in this step, and step).
8. Press the **[MHz(SET)]** key momentarily again, then rotate the **DIAL** knob to set this Item to “ON” (to enable the CW ID function). 
9. When you have made your selection, press and hold in the **[MHz(SET)]** key for one second to save the new setting and exit to normal operation.

To disable the CW Identifier:

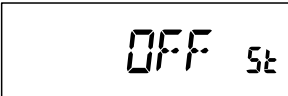
1. Press and hold in the **[MHz(SET)]** key for one second, then rotate the **DIAL** knob to select “11 CW ID”. 
2. Press the **[MHz(SET)]** key momentarily, then rotate the **DIAL** knob to set this Item to “OFF” (to disable the CW ID function). 
3. When you have made your selection, press and hold in the **[MHz(SET)]** key for one second to save the new setting and exit to normal operation.

 You may check your work by monitoring the entered callsign. To do this, re-call Set Mode Item “11 CW ID” and press the **[MHz(SET)]** key, then press the **[D/MR(MW)]** key.

The **FT-2980R/E** provides a CW Training feature, which sends random Morse Code via the sidetone (heard in the speaker), so you can improve your CW proficiency.

1. Press and hold in the **[MHz(SET)]** key for one second, then rotate the **DIAL** knob to select “12 CWTRNG”.
2. Press the **[MHz(SET)]** key momentarily to enable adjustment of this Set Mode Item.
3. Press the **[LOW(A/N)]** key to select the Training mode (displayed in fine print at the upper edge of the LCD):

The LCD display shows "12 CWTRNG" in a large, bold, digital font. The number "12" is positioned to the right of the text "CWTRNG".

- 1A: Sends five Alphabet characters only
- A: Sends Alphabet characters only (Repeatedly)
- 1n: Sends five Numeric characters only
- n: Sends Numeric characters only (Repeatedly)
- 1An: Sends five Alphabet, Numeric, “?”, and “/” characters (Mixed)
- An: Send Alphabet, Numeric, “?”, and “/” characters (Mixed, Continuously in group of five)

The LCD display shows "15WPM 1An" in a large, bold, digital font. The text "15WPM" is on the left and "1An" is on the right.

4. Rotate the **DIAL** knob to select the Morse speed. You may select the units of the code speed between “WPM (Words per minute)” and “CPM: characters per minute” by pressing the **[D/MR(MW)]** key.

The LCD display shows "75CPM 1An" in a large, bold, digital font. The text "75CPM" is on the left and "1An" is on the right.

5. Press the **[REV(DW)]** key to begin generation of the code characters (CW sidetone only, the radio does not transmit); the transmitted characters will appear on the display. If one of the “1” modes is selected in step 3 above, press the **[REV(DW)]** key to send another code group.

The LCD display shows "727EH 1An" in a large, bold, digital font. The text "727EH" is on the left and "1An" is on the right.

6. To disable the CW Training feature, press the **[MHz(SET)]** key momentarily.

7. Press and hold in the **[MHz(SET)]** key for one second to exit to normal operation.



The “CPM” selection is based on the international “PARIS” standard, which stipulates five characters per word.

Packet Operation

The **FT-2980R/E** may be used for 1200 bps Packet operation, using most all commonly-available Terminal Node Controllers (TNCs). Connections between the transceiver and the TNC are accomplished via the front panel Microphone connector and rear panel External Speaker jack, per the diagram below.

The audio level from the receiver to the TNC may be adjusted by using the **VOL** knob, as with voice operation. The input level to the **FT-2980R/E** from the TNC may be adjusted via Set Mode Item “27 MCGAIN;” see page 57 for details.

Be sure to turn the transceiver and TNC off before connecting the cables, so as to prevent voltage spikes from possibly damaging your transceiver.

Remember to readjust the default microphone input level to “LVL 5” (Set Mode Item “27 MCGAIN”) when Packet operation is finished.

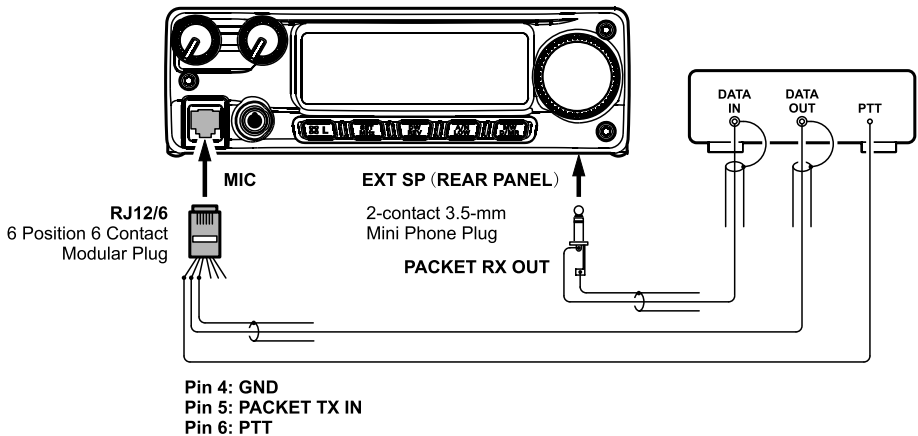





Password

The **FT-2980R/E** provides a password feature which can minimize the chance that your transceiver could be used by an unauthorized party.

When the password feature is activated, the radio will ask for the four digit password to be entered when the radio is first turned on. You must enter the four digit password from the Microphone's keypad. If the wrong password is entered, the microprocessor will shut down the radio automatically.

To enter the password and activating this feature, use the following procedure:

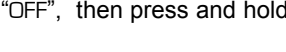
1. Press and hold in the **[MHz(SET)]** key for one second, then rotate the **DIAL** knob to select "40 PSWD". 
2. Press the **[MHz(SET)]** key momentarily to enable adjustment of this Set Mode Item. 
3. Press the **[LOW(A/N)]** key momentarily to display any previously-stored password. 
4. Rotate the **DIAL** knob to select the first digit of the desired number/letter (0-9, A, B, C, D, E (substitute for "*"), and F (substitute for "#")). 
5. Press the **[LOW(A/N)]** key to move to the next digit.
6. Repeat steps 4 and 5 to program the remaining numbers/letters of the desired password.
7. If you make a mistake, press the **[REV(DW)]** key to move back to the previous digit, then re-select the correct number/letter. 
8. When you have finished entering the password, press and hold in the **[MHz(SET)]** key for one second to save the new setting and exit to normal operation. 
9. If you wish to disable the Password feature, repeat steps 1 and 2 above, now rotate the **DIAL** knob to select "OFF", then press and hold in the **[MHz(SET)]** key for one second.



- 1) We recommend that you to write down the password number, and keep it in a safe place you can easily find if you forget your password.
- 2) If you forget the password number, you may turn on the transceiver by performing the "Microprocessor Resetting" procedure (see page 59). However, the **FT-2980R/E** will clear the password, as well as all memories, and will restore all other settings to factory defaults.

Miscellaneous Settings

Time-Out Timer (TOT)

The “Time-Out Timer” (TOT) feature is designed to force the transceiver into the “receive” mode after a preset time period of continuous transmission (the default is 3 minutes). This feature prevents your transceiver from transmitting a “dead carrier” for a long period of time in the event that the microphone **PTT** switch is accidentally locked in the “TX” condition.

The Time-Out Timer’s “switch-to-receive” time may be adjusted to 1/3/5/10 minutes, or Off.

To change the default (3 minutes) time setting:

1. Press and hold in the **[MHz(SET)]** key for one second, then rotate the **DIAL** knob to select “53 TOT”.
2. Press the **[MHz(SET)]** key, then rotate the **DIAL** knob to select the desired interval (1/3/5/10 minutes), or OFF.
3. Press and hold in the **[MHz(SET)]** key for one second to save the new setting and exit to normal operation.



TOT 53

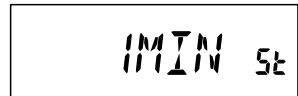

1MIN 5t



When your transmission time is within 10 seconds of the Time-Out Timer expiration, an Alert bell will provide an audible warning from the speaker.

Automatic Power-Off (APO)

The “Automatic Power-Off” (APO) feature will turn the radio completely *off* after a user-defined period of **PTT** or key/button inactivity. If you do not press any front panel keys or buttons, rotate the **DIAL** knob, use the microphone’s keys and buttons, or transmit, and so long as the transceiver is not scanning or engaged in priority monitoring, the radio will shut itself off after the specified time period. The available selections for the time before power-off are 0.5/1/3/5/8 hours, as well as APO Off. This feature is useful in minimizing battery drain in a mobile installation if you forget to turn the transceiver off when you leave your vehicle.

To activate the APO feature:

1. Press and hold in the **[MHz(SET)]** key for one second, then rotate the **DIAL** knob to select “1 APO”.
2. Press the **[MHz(SET)]** key, then rotate the **DIAL** knob to select the desired “switch-off” time or OFF.
3. Press and hold in the **[MHz(SET)]** key for one second to save the new setting and exit to normal operation.



APO 1



30MIN 5t

If there is no action by you within the time interval programmed, an Alert bell will provide an audible warning from the speaker within 1 minute of the APO Timer expiration, then the microprocessor will shut down the radio automatically.

Busy Channel Lock-Out (BCLO)

The BCLO feature prevents the radio's transmitter from being activated if a signal strong enough to break through the "noise" squelch is present. On a frequency where stations using different CTCSS or DCS codes may be active, BCLO prevents you from disrupting their communications accidentally (because your radio may be muted by its own Tone Decoder). The default setting for the BCLO is OFF, and here is how to change that setting:

1. Press and hold in the **[MHz(SET)]** key for one second, then rotate the **DIAL** knob to select "5 BCLO".
2. Press the **[MHz(SET)]** key momentarily to enable adjustment of this Set Mode Item.
3. Rotate the **DIAL** knob to set this Set Mode Item to "ON" (thus activating the BCLO feature).
4. When you have made your selection, press and hold in the **[MHz(SET)]** key for one second to save the new setting and exit to normal operation.

A rectangular LCD display showing the text "BCLO" on the left and the number "5" on the right.

A rectangular LCD display showing the text "ON" on the left and "St" on the right.





Remember that BCLO is controlled by the Noise Squelch; if you have DCS or TSQ engaged, BCLO will inhibit transmission if a station is on frequency but not transmitting the proper tone; BCLO will thus prevent you from interfering with the other station's transmission.

Miscellaneous Settings

Programming the Key Assignments

Default FT-2980R/E key functions have been assigned to the Microphone's [P1]/[P2]/[P3]/[P4] buttons at the factory. These may be changed by the user, if you wish to assign quick access to another function.

To change the assignments for the programmable keys:

1. Press and hold in the [MHz(SET)] key for one second, then rotate the **DIAL** knob to select the Menu Item to be configured ("36 PRG P1", "37 PRG P2", "38 PRG P3" or "39 PRG P4").

2. Press the [MHz(SET)] key, then rotate the **DIAL** knob to select the function you wish to assign to the button you selected in the previous step. The available choices are vary slightly among the four keys you may program, and they include:

ARTS: Engages the ARTS™ operation.

SQLOFF: Opens the Squelch to allow un-muted reception.

WX CH: Switches operation to the Weather channels bank.

S SRCH: Engages the Smart Search operation.

C SRCH: Engages the Tone Search Scanning feature.

SCAN: Engages the Scan operation

T CALL: Activates 1750 Hz Tone Burst

Button	Default
[P1]	SQLOFF
[P2]	S SRCH
[P3]	C SRCH
[P4]	WX CH (USA Version) T CALL (Asian/European Version)

or one of the Set Menu items that has been already assigned before.

If you want to assign your desired Set Mode item on the programmable key, see the description in the box shown below.

3. Press the [MHz(SET)] key momentarily to save the new setting, then rotate the **DIAL** knob to select another programmable button to modify, if desired, and repeat the above steps.
4. Press and hold in the [MHz(SET)] key for one second to exit to normal operation.

You may assign Set Mode items to the Microphone's [P1]/[P2]/[P3]/[P4] buttons, as well, to do this:

1. Press and hold in the [MHz(SET)] key for one second to enter the Set mode.
2. Rotate the **DIAL** knob to select the Set Mode Item which you wish to assign to the key as a Menu short-cut.
3. Press and hold in the Microphone's [P1], [P2], [P3], or [P4] button for one second to assign the Set Mode Item to that button.
4. Now you can recall this preferred Set Mode Item by simply pressing the Microphone's button momentarily.

FM Bandwidth & TX Deviation Level

You can reduce the receiver bandwidth and microphone deviation level when operating on tightly-clustered frequencies (channel spacing of 12.5 or 15 kHz). This will reduce the transmitter deviation, thus minimizing interference to other users.

To configure for the narrower bandwidth, use the following procedure:

1. Press and hold in the **[MHz(SET)]** key for one second, then rotate the **DIAL** knob to select "59 W/N DV".
2. Press the **[MHz(SET)]** key, then rotate the **DIAL** knob to change the display to "NARROW (± 2.5 kHz Deviation, 6 kHz Bandwidth)".
3. Press and hold in the **[MHz(SET)]** key for one second to save the new setting and exit to normal operation.
4. To return to wide bandwidth and deviation, repeat the above procedure, selecting "WIDE (± 5 kHz Deviation, 15 kHz Bandwidth)" in step 2 above.



W/N DV 59



NAR NARROW 5t

MIC Gain Setting

At the factory, a microphone gain has been programmed that should be satisfactory for the supplied **MH-48A6J** Microphone. If you use an after-market microphone or connect a TNC, you may wish to set a different Mic Gain level, using Set Mode item "27 MCGAIN".

1. Press and hold in the **[MHz(SET)]** key for one second, then rotate the **DIAL** knob to select "27 MCGAIN".
2. Press the **[MHz(SET)]** key, then rotate the **DIAL** knob to set the desired level (Default: LVL 5).
3. Press and hold in the **[MHz(SET)]** key for one second to save the new setting and exit to normal operation.



MCGAIN 27

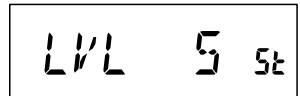

LVL 5 5t

Remember to readjust the default microphone input level to "LVL 5" when using the supplied **MH-48A6J** Microphone.

Miscellaneous Settings

DCS Code Inversion

The DCS system was first introduced in the commercial LMR (Land Mobile Radio) service, where it is now in widespread use. DCS is sometime referred to by its different proprietary names, such as DPL® (Digital Private Line®, a registered trademark of Motorola, Inc.).

DCS uses a codeword consisting of a 23-bit frame, transmitted (subaudible) at a data rate of 134.4 bps (bit/sec). Occasionally, signal inversion can result in the complement of a code to be sent or received. This prevents the receiver's squelch from opening with DCS enabled, as the decoded bit sequence would not match that selected for operation.

Typical situations that might cause inversion to occur are:

- Connection of an external receiver preamplifier.
- Operating through a repeater.
- Connection of an external linear amplifier.

Note that code inversion does not mean that any of the above listed equipment is defective! In certain amplifier configurations, the output signal (phase) is inverted from the input. Small signal or power amplifiers having an odd number (1, 3, 5, etc.) of amplification stages may result in inversion of a transmitted or received DCS code.

While under most circumstances this should not occur (amplifier designs and industry standards take this into account), if you find that your receiver squelch does not open when both you and the other station are using a common DCS code, you or the other station (but not both) can try the following:

1. Press and hold in the [MHz(SET)] key for one second, then rotate the **DIAL** knob to select "15 DCS RV".
2. Press the [MHz(SET)] key momentarily, then rotate the **DIAL** knob to set this Set Mode Item to "ENABLE" (thus inverting the DCS Code).
3. When you have made your selection, press and hold the [MHz(SET)] key for one second to save the new setting and exit to normal operation.
4. Remember to restore the default setting to "DISABLE" when done.



DCS RV 15



ENABLE 5t

In some instances of erratic or unpredictable operation, the cause may be corruption of data in the microprocessor (due to static electricity, etc.). If this happens, resetting of the microprocessor may restore normal operation. Note that all memories will be erased if you do a complete microprocessor reset, as described below.

Microprocessor Resetting

To clear all memories and other settings to factory defaults:

1. Turn the radio off.
2. Press and hold in the [**REV(DW)**], [**LOW(A/N)**], and [**D/MR(MW)**] keys while turning the radio on. The “ALL RESET PUSH D/MR KEY” notation will scroll on the display.
3. Press the [**D/MR(MW)**] key momentarily to reset all settings to their factory defaults (press any other key to cancel the Reset procedure).

Set Mode Resetting

To reset the Set (Menu) mode settings to their factory defaults, while leaving other settings unchanged:

1. Turn the radio off.
2. Press and hold in the [**LOW(A/N)**] and [**D/MR(MW)**] keys while turning the radio on. The “SET MODE RESET PUSH D/MR KEY” notation will scroll on the display.
3. Press the [**D/MR(MW)**] key momentarily to reset the Set (Menu) mode settings to their factory defaults (press any other key to cancel the Reset procedure).

Cloning

The **FT-2980R/E** includes a convenient “Clone” feature, which allows the memory and configuration data from one transceiver to be transferred to another **FT-2980R/E**. This can be particularly useful when configuring a number of transceivers for a public service operation. Here is the procedure for Cloning one radio’s data to another:

1. Turn both radios off.
2. Connect the user-constructed cloning cable between the **MIC** jacks of the two radios.
3. Press and hold in the [**LOW(A/N)**] key while turning the radios on. Do this for both radios (the order of switch-on does not matter). “CLONE” will appear on the displays of both radios when the Clone mode is successfully activated in this step.
4. On the **Destination radio**, press the [**D/MR(MW)**] key (“--WAIT--” will appear on the LCD).
5. Press the [**MHz(SET)**] key on the **Source radio**; “--TX--” will appear on the Source radio, and the data from this radio will be transferred to the other radio.
6. If there is a problem during the cloning process, “ERROR” will be displayed. Check your cable connections and battery voltage, and try again.
7. If the data transfer is successful, “CLONE” will appear on both displays.
8. Press any key to exit to normal operation.
9. Turn both radios off and disconnect the cloning cable.



CLONE



--WAIT--



--TX--



ERROR

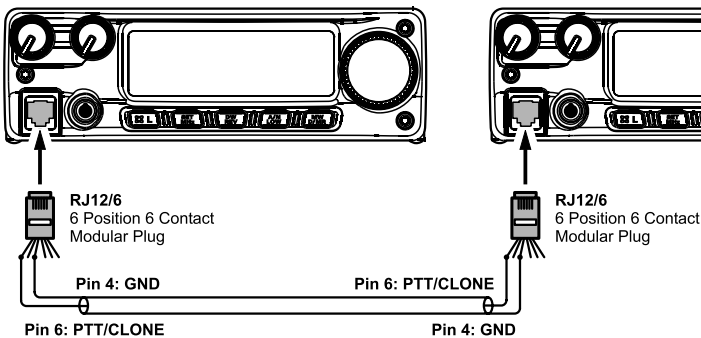

“Set” (Menu) Mode

The **FT-2980R/E** Set (Menu) mode, already described in parts of many previous chapters, is easy to activate and set. It may be used for configuration of a wide variety of transceiver parameters, some of which have not been detailed previously. Use the following procedure to activate the Set (Menu) mode:

1. Press and hold in the **[MHz(SET)]** key for one second to enter the Set mode.
2. Rotate the **DIAL** knob to select the Menu Item to be adjusted.
3. Press the **[MHz(SET)]** key momentarily to enable adjustment of the selected Menu item, then rotate the **DIAL** knob to perform the actual adjustment.
4. After completing your selection and adjustment, press and hold in the **[MHz(SET)]** key for one second to exit the Set mode and resume normal operation.

Menu Item	Function	Available Values	Default
1APO	Enables/Disables the Automatic Power Off feature.	30MIN / 1HOUR / 3HOUR / 5HOUR / 8HOUR / OFF	OFF
2AR BEP	Selects the Beep option during ARTS™ operation.	IN RNG / ALWAYS / OFF	IN RNG
3AR INT	Selects the Polling Interval during ARTS™ operation.	25SEC / 15SEC	25SEC
4ARS	Activates/Deactivates the Automatic Repeater Shift feature.	ON / OFF	ON
5BCLO	Enables/Disables the Busy Channel Lock-Out feature.	ON / OFF	OFF
6BEEP	Enables/Disables the key beeper.	KY+SCN / KEY / OFF	KY+SCN
7BELL	Selects the CTCSS/DCS/EPCS Bell Ringer repetitions.	1 / 3 / 5 / 8 / CNTNUE / OFF	OFF
8BNK.LNK	Select the Memory Bank for the Memory Bank Link Scan.	---	---
9BNK.NM	Programming an Alpha/Numeric label for a Memory Bank.	---	---
10CLK.SFT	Shifting of the CPU clock frequency.	ON / OFF	OFF
11CW ID	Enables/Disables the CW identifier during ARTS™ Operation.	ON / OFF	OFF
12CWTRNG	Enables/Disables the CW Training feature and selects the sending speed of the morse Code.	4WPM - 13WPM / 15WPM / 17WPM / 20WPM / 24WPM / 30WPM / 40WPM / OFF (20CPM - 65CPM (5CPM multiples) / 75CPM / 85CPM / 100CPM / 120CPM / 150CPM / 200CPM)	OFF
13DC VLT	Indicates the DC Supply Voltage.	---	---
14DCS CD	Setting of the DCS code.	104 standard DCS codes	023
15DCS RV	Enables/Disables “Inverted” DCS code decoding.	ENABLE / DISABL	DISABL
16DIMMER	Setting of the front panel display’s illumination level.	LVL 0 (OFF) - LVL 10	LVL 5
17DT A/M	Enables/Disables the DTMF Autodialer feature.	MANUAL / AUTO	MANUAL
18DT DLY	Setting of the DTMF Autodialer’s TX Delay Time.	50 / 250 / 450 / 750 / 1000 (ms)	450 (ms)
19DT SET	Loading of the DTMF Autodialer Memories.	---	---

“Set” (Menu) Mode

Menu Item	Function	Available Values	Default
20DT SPD	Setting of the DTMF Autodialer Sending Speed.	50 / 100 (ms)	50 (ms)
21EDG.BEP	Enables/Disable the Band-edge beeper while scanning.	ON / OFF	OFF
22INT CD	Selects the Access Number (DTMF digit) for WiRES™ operation.	DTMF 0 - DTMF 9 / DTMF A -DTMF F	DTMF 1
23INT MD	Selects the Internet Link Connection mode.	SRG / FRG	SRG
24INT.A/M	Enables/Disables DTMF Autodialer feature while operating on the Internet Connection feature.	MANUAL / AUTO	MANUAL
25INT.SET	Selects the memory register for an Access Number (DTMF code) for non-WiRES™ Internet Link System access.	---	---
26LOCK	Selects the Control Locking Lockout combination.	KEY / DIAL / K+D / PTT / K+P / D+P / ALL	K+D
27MCGAIN	Adjust the microphone gain level.	LVL 1 -LVL 9	LVL 5
28MEM.SCN	Selects the Memory Scan mode.	TAG1 / TAG2 / ALL CH	ALL CH
29MW MD	Selects the method of selection of channels for Memory Storage.	NEXT / LOWER	NEXT
30NM SET	Programming an Alpha/Numeric label for a Memory Channel.	---	---
31OPN.MSG	Selects the Opening Message that appears when the radio is powered on.	DC / MSG / OFF	DC
32PAGER	Enables/Disables the Enhanced CTCSS Paging & Code Squelch function.	ON / OFF	OFF
33PAG.ABK	Enables/Disables the Answer Back function of the Enhanced CTCSS Paging & Code Squelch function.	ON / OFF	OFF
34PAG.CDR	Setting the Receiver Pager Code for the Enhanced CTCSS Paging & Code Squelch function.	---	05_47
35PAG.CDT	Setting the Transmitting Pager Code for the Enhanced CTCSS Paging & Code Squelch function.	---	05_47
36PRG P1	Programming the function assigned to Microphone's [P1] key.	ARTS / DC VLT / DIMMER / MCGAIN / SKIP / SQL OFF / WX CH / S SRCH / C SRCH / SCAN / T CALL / one of the Set Menu items	SQL OFF
37PRG P2	Programming the function assigned to Microphone's [P2] key.		S SRCH
38PRG P3	Programming the function assigned to Microphone's [P3] key.		C SRCH
39PRG P4	Programming the function assigned to Microphone's [P4] key.		×1
40PSWD	Programs and activates the Password feature.	---	OFF
41RESUME	Selects the Scan Resume mode.	BUSY / HOLD / 3SEC / 5SEC / 10SEC	BUSY
42RF SQL	Adjusts the RF Squelch threshold level.	S1 - S9 or OFF	OFF
43RPT	Sets the Repeater Shift direction.	-RPT / +RPT / SIMP	SIMP
44RVRT	Enables/Disables the “Priority Channel Revert” feature.	ON / OFF	OFF
45S SRCH	Selects the Smart Search Sweep mode.	SINGLE / CNTNUE	SINGLE
46SHIFT	Sets the magnitude of the Repeater Shift.	0.00-99.95 (MHz)	0.60 (MHz)

“Set” (Menu) Mode

Menu Item	Function	Available Values	Default
47SKIP	Selects the Memory Scan mode.	SKIP / ONLY / OFF	OFF
48SPLIT	Enables/Disables the split CTCSS/DCS coding.	ON / OFF	OFF
49SQL.TYP	Selects the Tone Encoder and/or Decoder mode.	TONE / TSQL / DCS / RV TN / OFF	OFF
50STEP	Sets the Synthesizer steps.	5k / 10k / 12.5k / 15k / 20k / 25k / 50k / 100k (Hz)	×2
51TEMP	Indicates the current temperature inside the transceiver's case.	---	---
52TN FRQ	Setting of the CTCSS Tone Frequency.	50 standard CTCSS tones	100.0 (Hz)
53TOT	Sets the Time-Out Timer.	1MIN / 3MIN / 5MIN / 10MIN / OFF	3MIN
54TS MUT	Enables/Disables the receiver audio output during the Tone Search Scanner is activated.	ON / OFF	ON
55TS SPD	Selects the Tone Search Scanner speed.	FAST / SLOW	FAST
56VFO.SCN	Select the VFO Scanner Width.	±1MHz / ±2MHz / ±5MHz / ALL	ALL
57WX ALT	Enables/Disables the Weather Alert feature.	ON / OFF	OFF
58WX VOL	Selects the audio output level of the Weather Alert.	NOR.VOL / MAX.VOL	NOR.VOL
59W/N DV	Reduction of the Microphone Gain/Deviation and receiver bandwidth.	WIDE / NARROW	WIDE

×1: WX CH (USA version), T CALL (Asian/European version)

×2: 5 kHz (USA version), 12.5 kHz (Asian/European version)

“Set” (Menu) Mode

Menu Selection Details

1 APO

Function: Enables/Disables the Automatic Power Off feature.

Available Values: 30MIN / 1HOUR / 3HOUR / 5HOUR / 8HOUR / OFF

Default: OFF

2 AR BEP

Function: Selects the Beep option during ARTS operation.

Available Values: IN RNG / ALWAYS / OFF

Default: IN RNG

IN RNG: Beeps sound only when the radio first detects that you are within range.

ALWAYS: Beeps sound every time a polling transmission is received from the other station (every 15 or 25 seconds when in range).

OFF: No alert beeps sound.

3 AR INT

Function: Selects the Polling Interval during ARTS operation.

Available Values: 25SEC / 15SEC

Default: 25SEC

4 ARS

Function: Activates/Deactivates the Automatic Repeater Shift feature.

Available Values: ON / OFF

Default: ON

5 BCLO

Function: Enables/Disables the Busy Channel Lock-Out feature.

Available Values: ON / OFF

Default: OFF

6 BEEP

Function: Enables/Disables the key beeper.

Available Values: KY+SCN / KEY / OFF

Default: KY+SCN

KY+SC: The beeper sounds when you press any key, or when the scanner stops.

KEY: The beeper sounds when you press any key.

OFF: Beeper is disabled.

7 BELL

Function: Selects the CTCSS/DCS/EPCS Bell Ringer repetitions.

Available Values: 1 / 3 / 5 / 8 / CNTNUE (Continuous ringing) / OFF

Default: OFF

8 BNK.LNK

Function: Selects the Memory Bank(s) for the Memory Bank Link Scan.

See page 41 for details.

9 BNK NM

Function: Programming an Alpha/Numeric label for a Memory Bank.

See page 35 for details.

10 CLK.SFT

Function: Shifting of the CPU clock frequency.

Available Values: ON / OFF

Default: OFF

This function is only used to move a spurious response “birdie”, should it fall on a desired frequency.

11 CW ID

Function: Enables/Disables the CW identifier during ARTS Operation.

Available Values: ON / OFF

Default: OFF

12 CWTRNG

Function: Enables/Disables the CW Training feature and selects the sending speed of the Morse Code groups.

Available Values: 4 / 5 / 6 / 7 / 8 / 9 / 10 / 11 / 12 / 13 / 15 / 17 / 20 / 24 / 30 / 40 WPM
/ OFF or 20 / 25 / 30 / 35 / 40 / 45 / 50 / 55 / 60 / 65 / 75 / 85 / 100 /
120 / 150 / 200 CPM

Default: OFF

Note: To switch units between “WPM” and “CPM”, just press the [MHz(SET)] key.

13 DC VLT

Function: Indicates the DC Supply Voltage.

14 DCS CD

Function: Setting of the DCS code.

Available Values: 104 standard DCS codes

Default: 023

DCS CODE											
023	025	026	031	032	036	043	047	051	053	054	065
071	072	073	074	114	115	116	122	125	131	132	134
143	145	152	155	156	162	165	172	174	205	212	223
225	226	243	244	245	246	251	252	255	261	263	265
266	271	274	306	311	315	325	331	332	343	346	351
356	364	365	371	411	412	413	423	431	432	445	446
452	454	455	462	464	465	466	503	506	516	523	526
532	546	565	606	612	624	627	631	632	654	662	664
703	712	723	731	732	734	743	754	-	-	-	-

15 DCS RV

Function: Enables/Disables “Inverted” DCS code decoding.

Available Values: ENABLE / DISABL

Default: DISABL

16 DIMMER

Function: Setting of the front panel display’s illumination level.

Available Values: 0 (OFF) - 10

Default: 5

“Set” (Menu) Mode

17 DT A/M

Function: Enables/Disables the DTMF Autodialer feature.

Available Values: MANUAL / AUTO

Default: MANUAL

18 DT DLY

Function: Setting of the DTMF Autodialer's TX Delay Time.

Available Values: 50 / 250 / 450 / 750 / 1000 ms

Default: 450 ms

19 DT SET

Function: Loading of the DTMF Autodialer Memories.

See page 28 for details.

20 DT SPD

Function: Setting of the DTMF Autodialer Sending Speed.

Available Values: 50 (high speed) / 100 (low speed) ms

Default: 50 ms

21 EDG.BEP

Function: Enables/Disable the Band-edge beeper while scanning.

Available Values: ON / OFF

Default: OFF

22 INT CD

Function: Selects the Access Numbers (DTMF digits) for WIRES™ Internet linking.

Available Values: DTMF 0 - DTMF 9 / DTMF A - DTMF F

Default: DTMF 1

23 INT MD

Function: Selects the Internet Link Connection mode.

Available Values: SRG / FRG

Default: SRG

24 INT.A/M

Function: Enables/Disables DTMF Autodialer feature while using the Internet Connection feature.

Available Values: MANUAL / AUTO

Default: MANUAL

25 INT.SET

Function: Selects the memory register for an Access Number (DTMF code) for non-WIRES Internet Link System access.

Available Values: F0 - F9

Default: F1

26 LOCK

Function: Selects the Control Locking Lockout combination.

Available Values: KEY / DIAL / K+D / PTT / K+P / D+P / ALL

Default: OFF

Note: “K” = “Key;” “D” = “Dial;” and “P” = “PTT”.

27 MCGAIN

Function: Adjust the microphone gain level.

Available Values: 1 - 9

Default: 5

28 MEM.SCN

Function: Selects the Memory Scan mode.

Available Values: TAG1 / TAG2 / ALL CH

Default: ALL CH

ALL CH: The scanner sweeps all Memory channels.

TAG1: The scanner sweeps only those Memory channels with the same “first” digit of the alpha/numeric tag as the first channel on which scanning started.

TAG2: The scanner sweeps only those Memory channels with the same “first” and “second” digits of the alpha/numeric tag as the first channel on which scanning started.

29 MW MD

Function: Selects the method of selection of channels for Memory Storage.

Available Values: NEXT / LOWER

Default: NEXT

NEXT: Stores the data into the memory channel which is next-highest from the **last-stored** memory channel.

LOWER: Stores the data into the lowest-available “free” channel.

30 NM SET

Function: Programming an Alpha/Numeric label for a Memory Channel.

See page 33 for details.

31 OPN.MSG

Function: Selects the Opening Message that appears when the radio is powered on.

Available Values: DC / MSG / OFF

Default: DC

DC: DC supply voltage

MSG: Set by user. See below.

OFF: No Opening Message

Here's how to program the Opening Message:

1. Set this Set Mode Item to “MSG”.
2. Press the [**LOW(A/N)**] key momentarily to enable programming of the opening message. You will notice the first character entry's location blinking.
3. Rotate the **DIAL** knob to select the first letter/number of the message, then press the [**LOW(A/N)**] key momentarily to save the first letter/number and move on to the next character.
4. Repeat the previous step as necessary to complete the message (up to six characters).
5. If you make a mistake, press the [**DW(REV)**] key to back-space the cursor; now re-enter the correct letter/number.
6. When you have entered the desired opening message, press the [**MHz(SET)**] key momentarily to confirm the message, then press and hold in the [**MHz(SET)**] key for one second to save the settings and exit to normal operation.

“Set” (Menu) Mode

32 PAGER

Function: Enables/Disables the Enhanced CTCSS Paging & Code Squelch function.

Available Values: ON / OFF

Default: OFF

33 PAG.ABK

Function: Enables/Disables the Answer Back function of the Enhanced CTCSS Paging & Code Squelch function.

Available Values: ON / OFF

Default: OFF

34 PAG.CDR

Function: Setting the Receiver Pager Code for the Enhanced CTCSS Paging & Code Squelch function.

See page 25 for details.

35 PAG.CDT

Function: Setting the Transmitting Pager Code for the Enhanced CTCSS Paging & Code Squelch function.

See page 25 for details.

36 PRG P1

Function: Programming the function assigned to Microphone's [P1] key.

Available Values: ARTS / SQL OFF / WX CH / S SRCH / C SRCH / SCAN / T CALL or one of the all Set mode items (except Set mode item #36 through 39; initial setting is “Set mode item #13 DC VLT”).

Default: SQL OFF

37 PRG P2

Function: Programming the function assigned to Microphone's [P2] key.

Available Values: ARTS / SQL OFF / WX CH / S SRCH / C SRCH / SCAN / T CALL or one of the all Set mode items (except Set mode item #36 through 39; initial setting is “Set mode item #16 DIMMER”).

Default: S SRCH

38 PRG P3

Function: Programming the function assigned to Microphone's [P3] key.

Available Values: ARTS / SQL OFF / WX CH / S SRCH / C SRCH / SCAN / T CALL or one of the all Set mode items (except Set mode item #36 through 39; initial setting is “Set mode item #27 MCGAIN”).

Default: C SRCH

39 PRG P4

Function: Programming the function assigned to Microphone's [P4] key.

Available Values: ARTS / SQL OFF / WX CH / S SRCH / C SRCH / SCAN / T CALL or one of the all Set mode items (except Set mode item #36 through 39; initial setting is “Set mode item #47 SKIP”).

Default: USA Version: WX CH, Asian/European Version : T CALL

40 PSWD

Function: Programs and activates the Password feature.

Available Values: ON / OFF

Default: OFF

41 RESUME

Function: Selects the Scan Resume mode.

Available Values: BUSY / HOLD / 3SEC / 5SEC / 10SEC

Default: BUSY

BUSY: The scanner will hold until the signal disappears, then will resume when the carrier drops.

HOLD: The scanner will stop when a signal is received, and will not re-start.

3SEC/5SEC/10SEC: The scanner will hold for the selected resume time, then resume whether or not the other station is still transmitting.

42 RF SQL

Function: Adjusts the RF Squelch threshold level.

Available Values: S1 - S9 / OFF

Default: OFF

43 RPT

Function: Sets the Repeater Shift direction.

Available Values: -RPT / + RPT / SIMP

Default: SIMP

44 RVRT

Function: Enables/disables the “Priority Channel Revert” feature.

Available Values: ON / OFF

Default: OFF

45 S SRCH

Function: Selects the Smart Search Sweep mode.

Available Values: SINGLE / CNTNUE

Default: SINGLE

SINGLE: The transceiver sweeps the current band once in each direction, starting on the current frequency. All channels where activity is present (up to 15 in each direction) are loaded into the Smart Search memories. Whether or not all 31 memories are filled, the search stops after one sweep in each direction.

CNTNUE: The transceiver makes a sweep in each direction as with the “SINGLE” mode, but if all 31 channels are not filled after the first sweep, the radio continues sweeping until they *are* all filled.

46 SHIFT

Function: Sets the magnitude of the Repeater Shift.

Available Values: 0.00 - 99.95 MHz

Default: 0.60 MHz

“Set” (Menu) Mode

47 SKIP

Function: Selects the Memory Scan mode.

Available Values: SKIP / ONLY / OFF

Default: OFF

SKIP: The scanner will “skip” the flagged channels during scanning.

ONLY: The scanner will only scan channels that are flagged (Preferential Scan List).

OFF: All memory channels will be scanned (the “flag” will be ignored).

48 SPLIT

Function: Enables/Disables split CTCSS/DCS coding.

Available Values: ON / OFF

Default: OFF

When this Set Mode Item is set to “ON”, you will see the following additional parameters after the “RV TN” parameter while configuring Set Mode Item “49 SQL.TYP”.

D CODE: DCS Encode only.

T DCS: Encodes a CTCSS tone and Decodes a DCS code.

D TONE: Encodes a DCS code and Decodes a CTCSS tone.

49 SQL.TYP

Function: Selects the Tone Encoder and/or Decoder mode.

Available Values: TONE / TSQL / DCS / RV TN / OFF

Default: OFF

TONE: CTCSS Encoder

TSQL: CTCSS Encoder/Decoder

DCS: Digital Coded Encoder/Decoder

RV TN: Reverse CTCSS Decoder (Mutes receiver when matching tone is received)

Note: See also Set Mode Item “48 SPLIT” regarding additional selections available during “Split Tone” operation.

50 STEP

Function: Sets the Synthesizer steps.

Available Values: 5 / 10 / 12.5 / 15 / 20 / 25 / 50 / 100 kHz

Default: USA Version: 5 kHz, Asian/European Version: 12.5 kHz

51 TEMP

Function: Indicates the current temperature inside the transceiver’s case.

Note: Press the [D/MR(MW)] key repeatedly to toggle between Fahrenheit (°F) and Celsius (°C) display of the temperature.

52 TN FRQ

Function: Setting of the CTCSS Tone Frequency.

Available Values: 50 standard CTCSS tones

Default: 100.0 Hz

CTCSS TONE FREQUENCY (Hz)									
67.0	69.3	71.9	74.4	77.0	79.7	82.5	85.4	88.5	91.5
94.8	97.4	100.0	103.5	107.2	110.9	114.8	118.8	123.0	127.3
131.8	136.5	141.3	146.2	151.4	156.7	159.8	162.2	165.5	167.9
171.3	173.8	177.3	179.9	183.5	186.2	189.9	192.8	196.6	199.5
203.5	206.5	210.7	218.1	225.7	229.1	233.6	241.8	250.3	254.1

53 TOT

Function: Sets the Time-Out Timer.

Available Values: 1MIN / 3MIN / 5MIN / 10MIN / OFF

Default: 3MIN

The time-out timer shuts off the transmitter after continuous transmission of the programmed time.

54 TS MUT

Function: Enables/Disables the receiver audio output while the Tone Search Scanner is activated.

Available Values: ON / OFF

Default: ON

55 TS SPD

Function: Selects the Tone Search Scanner speed.

Available Values: FAST / SLOW

Default: FAST

56 VFO.SCN

Function: Selects the VFO Scanner Width.

Available Values: ± 1 MHz / ± 2 MHz / ± 5 MHz / ALL

Default: ALL

± 1 MHz, ± 2 MHz, ± 5 MHz: The scanner will sweep frequencies within the selected bandwidth.

ALL: The scanner will sweep all frequencies.

57 WX ALT

Function: Enables/Disables the Weather Alert feature.

Available Values: ON / OFF

Default: OFF

58 WX VOL

Function: Selects the audio output level of the Weather Alert Tone.

Available Values: NOR.VOL / MAX.VOL

Default: NOR.VOL

59 W/N DV

Function: Reduction of the Microphone Gain/Deviation and receiver bandwidth.

Available Values: WIDE (± 5 kHz Deviation, 15 kHz Bandwidth) / NARROW (± 2.5 kHz Deviation, 6 kHz Bandwidth)

Default: WIDE (± 5 kHz Deviation, 15 kHz Bandwidth)

Maintenance

The inherent quality of the solid-state components used in this transceiver will provide many years of continuous use.

In the unlikely event of problems, please contact your Dealer or our repair facility.

In the unlikely event that the radio fails to perform or needs servicing, please contact your Dealer. An "RA" (Return Authorization) number is not necessary to send a product in for service. Include a brief note describing the problem along with your name, return address, phone number, and proof of purchase.

Storage of packing Materials and transportation

Store all packing materials for the transceiver for future use, such as when transporting the transceiver when moving or requesting after service.

This transceiver is precise and sensitive. To prevent it from being damaged during transportation, the transceiver must be packed with its original packing materials.

General

Frequency Range:	Tx 136 - 174 MHz (Asian version) 144 - 148 MHz (USA version) 144 - 146 MHz (European version) Rx 136 - 174 MHz
Channel Step:	5/10/12.5/15/20/25/50/100 kHz
Standard Repeater Shift:	±600 kHz
Frequency Stability:	Better than ±10 ppm [−4 °F to +140 °F (−20 °C to +60 °C)]
Modes of Emission:	F2D/F3E
Antenna Impedance:	50 Ohms, unbalanced
Supply voltage:	13.8 V DC ±15 %, negative ground
Current Consumption (typical):	Rx: less than 0.7 A, less than 0.3 A (squelched) Tx: 15 A (80 W) / 9 A (30 W) / 5 A (10 W) / 4 A (5 W)
Operating Temperature Range:	−4° F to +140° F (−20° C to +60° C)
Case Size (WxHxD):	6.3" x 2" x 7.3" (160 x 50 x 185 mm) (w/o knobs)
Weight (Approx.):	4.2 lb (1.9 kg)

Transmitter

Output Power:	80 W / 30 W / 10 W / 5 W
Modulation Type:	Variable Reactance
Maximum Deviation:	±5 kHz (Wide) ±2.5 kHz (Narrow)
Spurious Radiation:	Better than −60 dB
Microphone Impedance:	2 k-Ohms

Receiver

Circuit Type:	Double Conversion Superheterodyne
I_fs:	21.7 MHz & 450 kHz
Sensitivity (for 12dB SINAD):	Better than 0.4 μV
Selectivity (−6/−60dB):	12 kHz/28 kHz (Wide) 9 kHz/22 kHz (Narrow)
IF Rejection:	Better than 70 dB
Image Rejection:	Better than 70 dB
Maximum AF Output:	3 W into 4 Ohms @10 % THD

Specifications subject to change without notice or obligation. Specifications guaranteed only within Amateur band.

Frequency ranges will vary according to transceiver version; check with your dealer.

Symbols placed on the equipment

⎓ Direct current

After-market Services

The warranty period is 3 years from the date of purchase

The warranty certification is enclosed with the product. Malfunction resulting from normal use of the product in accordance with the Operating Manual instructions, shall be repaired free-of-charge within a 3-year period from the date of purchase.

Keep the warranty certificate in a safe location

When the warranty certificate is lost, failures which occur during the warranty period will be treated as chargeable non-warranty claims.

Contact Yaesu Service Center for non-warranty repairs

Repairs will be made at the user's expense if normal functions can be maintained after the repair. Please check with the retail store or Yaesu service center for more information.

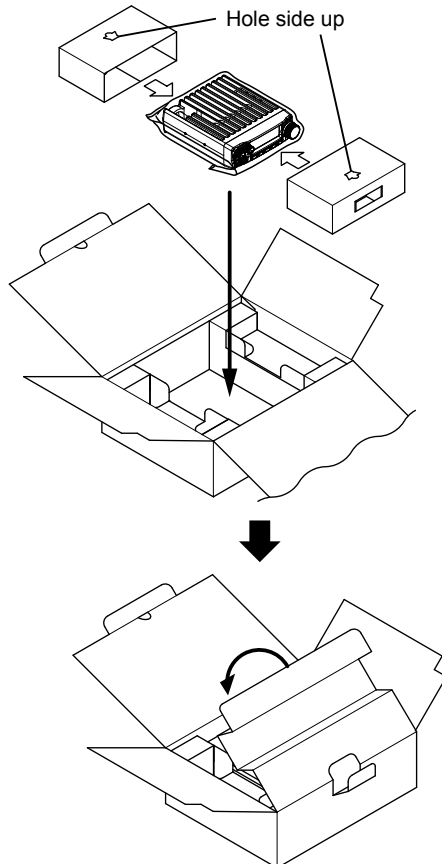

1. Changes or modifications to this device not expressly approved by YAESU MUSEN could void the user's authorization to operate this device.
2. This device complies with part 15 of the FCC Rules. Operation is subject to the following two conditions: (1) This device may not cause harmful interference, and (2) this device must accept any interference including received, interference that may cause undesired operation.
3. The scanning receiver in this equipment is incapable of tuning, or readily being altered, by the User to operate within the frequency bands allocated to the Domestic public Cellular Telecommunications Service in Part 22.

This device complies with Industry Canada license-exempt RSS standard(s). Operation is subject to the following two conditions: (1) this device may not cause interference, and (2) this device must accept any interference, including interference that may cause undesired operation of the device.

Le présent appareil est conforme aux CNR d'Industrie Canada applicables aux appareils radio exempts de licence. L'exploitation est autorisée aux deux conditions suivantes : (1) l'appareil ne doit pas produire de brouillage, et (2) l'utilisateur de l'appareil doit accepter tout brouillage radioélectrique subi, même si le brouillage est susceptible d'en compromettre le fonctionnement.

DECLARATION BY MANUFACTURER

The Scanner receiver is not a digital scanner and is incapable of being converted or modified to a digital scanner receiver by any user.

WARNING: MODIFICATION OF THIS DEVICE TO RECEIVE CELLULAR RADIOTELEPHONE SERVICE SIGNALS IS PROHIBITED UNDER FCC RULES AND FEDERAL LAW.

EU Declaration of Conformity

We, Yaesu Musen Co. Ltd of Tokyo, Japan, hereby declare that this radio equipment FT-2980E is in full compliance with EU Radio Equipment Directive 2014/53/EU. The full text of the Declaration of Conformity for this product is available to view at <http://www.yaesu.com/jp/red>

ATTENTION – Conditions of usage

This transceiver works on frequencies that are regulated and not permitted to be used without authorisation in the EU countries shown in this table. Users of this equipment should check with their local spectrum management authority for licensing conditions applicable for this equipment.

					
AT	BE	BG	CY	CZ	DE
DK	ES	EE	FI	FR	UK
GR	HR	HU	IE	IT	LT
LU	LV	MT	NL	PL	PT
RO	SK	SI	SE	CH	IS
LI	NO	–	–	–	–

Disposal of Electronic and Electrical Equipment

Products with the symbol (crossed-out wheeled bin) cannot be disposed as household waste.

Electronic and Electrical Equipment should be recycled at a facility capable of handling these items and their waste by-products.

Please contact a local equipment supplier representative or service center for information about the waste collection system in your country.



YAESU

The radio

Copyright 2017

YAESU MUSEN CO., LTD.

All rights reserved.

No portion of this manual may be
reproduced without the permission of
YAESU MUSEN CO., LTD.

YAESU MUSEN CO., LTD.

Tennozu Parkside Building
2-5-8 Higashi-Shinagawa, Shinagawa-ku, Tokyo 140-0002 Japan

YAESU USA

6125 Phyllis Drive, Cypress, CA 90630, U.S.A.

YAESU UK

Unit 12, Sun Valley Business Park, Winnall Close
Winchester, Hampshire, SO23 0LB, U.K.

1710Y-BS

Printed in China

