

The radio... **YAESU**

In Homage to Sako Hasegawa

FTDX101MP 200W

HF/50MHz TRANSCEIVER

The Ultimate

FTDX101D 100W

HF/50MHz TRANSCEIVER



The Transceiver that could only be created by Yaesu
Offering Exciting New Features and Extraordinary RF Performance
Operator On-the-Air Flexibility and Convenience Never Experienced Before

In Homage to Sako Hasegawa **FTDX101MP**
The Ultimate **FTDX101D**

Historical Heritage

For over 60 years Yaesu has earned the acclaim,
respect and trust of DXers around the World

Our Excellence in Radio Design
and Engineering is a Historical Fact





FTDX101 Series The Definitive Choice

Uncompromising RF Design resulting in the Best Performance
Down-Conversion that provides sharpest adjacent QRM reduction
Hybrid SDR: Narrow Bandwidth SDR & Direct Sampling SDR

- 9MHz IF Roofing Filter Producing Excellent Shape Factor
- 400MHz HRDDS (High Resolution Direct Digital Synthesizer) for Outstanding Local-Oscillator Performance
- Hybrid SDR configuration with a Narrow Bandwidth SDR and a Direct Sampling SDR
- 18 bit A/D Converter Narrow Bandwidth SDR provides high performance digital data processing
 - Frequency automatic adjustment RF Preselector with high precision stepping motor provides maximum attenuation of -70dB
 - Yaesu Renowned Interference Reduction Systems (WIDTH / SHIFT / NOTCH / CONTOUR / DNR / DNF / APF)
- MAIN and SUB Dual Receivers with Completely Independent from RF Front-End to SDR stages
- Stable 200W TX Operation with 50 VDC Supply (MP version)



Accumulated RF Technology Knowledge

We believe that hearing a weak target signal in a strong interference environment is the most important performance required of HF DX communications equipment in any era. We carefully examine the newest contemporary technology while, at the same time, making use of accumulated experience and technical knowledge to create the very best equipment. This is the Attitude of the True Pioneer

YAESU Legendary Powerful RF Front-End and Outstanding Low Noise Local Oscillator

The RF Front-End is an important part affecting the performance of the whole receiver circuit configuration of the transceiver. In the FTDX101, further tuning is carried out utilizing a powerful RF Front-End having 15 divided BPF (Band pass filter), RF amplifier with low NF (Noise figure) excellent intermodulation characteristics proved with the FTDX5000. Also, in the reference oscillation circuit, HRDDS was employed which generates local frequency directly from 400 MHz; a performance design adopted in FTDX9000 and FTDX5000. We carefully selected the latest circuit configuration and low noise element manufactured by FPGA to further improve C/N characteristics resulting in a Proximity (2 kHz) BDR (Blocking Dynamic Range) of 150 dB in the 14 MHz band while the RMDR (Reciprocal Mixing Dynamic Range) reaches 120 dB.

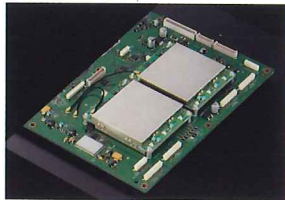

400MHz HRDDS unit

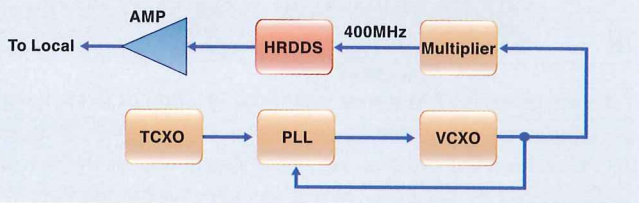

Local Oscillator block diagram

Down Conversion

Similar to the FTDX5000, the first IF frequency is 9 MHz and a high-quality FET D quad Double Balanced Mixer (DBM) is implemented in the mixer section. The 3 kHz roofing filter for SSB and 600 Hz CW filter have excellent shape factors, which produce outstanding out of band attenuation characteristics. The down conversion method attenuates unwanted frequency mixer components outside the band and cleaner signal is input to the following A / D converter.



600Hz Crystal Roofing Filter

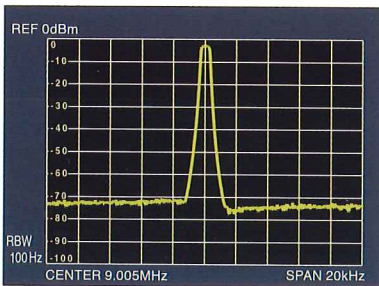

Roofing Filter Characteristics

Third Generation RF Preselector RF VC-TUNE

Our newly developed VC tuning circuit drives a variable-capacitor uses a high precision stepping motor; a remarkable miniaturization design. With this circuit, an astonishing damping characteristic of -70 dB maximum attenuation compared to the conventional preset method of switching the coil and the capacitor with a relay. The high precision stepping motor covers the band continuously as it follows the movement of the selected frequency by the operator. There is no unnatural awareness at the time of relay switching. Interference that can be created by multiple strong signals in the band can further rejected by fine-tuning for optimum improvement simply by turning the ring on the Main Dial by pressing the VC-TUNE switch on the upper right of the VFO dial.

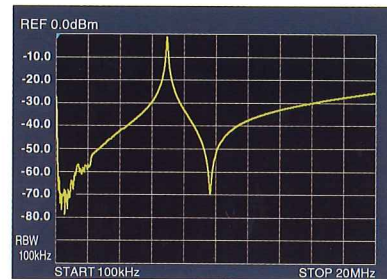

VC-TUNE characteristics

Renowned Interference Reduction Systems

Various proven interference reduction systems such as WIDTH / SHIFT / NOTCH / CONTOUR / APF (audio peaking filter) / DNF (digital notch filter) / DNR (digital noise reduction) / NB (noise blanker) are included for the MAIN and the SUB receivers. Front panel controls for each of these systems are arranged independently for each of the two receivers allow flexible tuning to effectively reduce interference that may appear on your selected receive frequency.

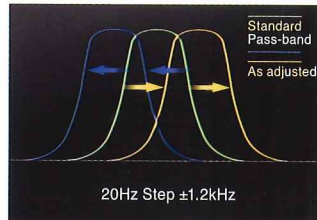

IF SHIFT function

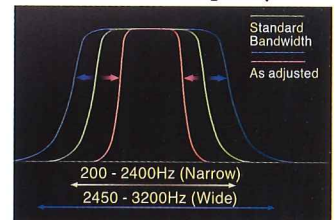

IF WIDTH function (LSB/USB)

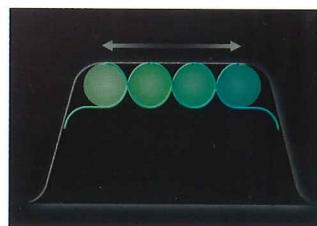

CONTOUR Chart

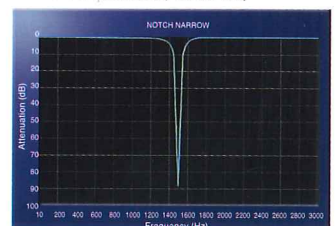

IF NOTCH Characteristics

Hybrid SDR

Narrow band SDR + Direct Sampling SDR

Emphasizes Basic Performance and Hybrid SDR Functionality

Digital Processing Generated Real-Time Spectrum Scope

Narrow Band SDR with 18bit A/D converter + Direct Sampling SDR with 14bit A/D converter

There are two methods of SDR reception, one is a direct sampling method and the second is a superheterodyne method. The direct sampling method is known as broadband SDR, and the superheterodyne method is known as narrowband SDR.

Direct Sampling

This method of directly converting a frequency from the RF Front-End to a digital signal with the A/D converter is direct A/D conversion without attenuating any extraneous frequency components passing through the BPF (Band Pass Filter). If there are multiple strong received signals in the pass band of the RF Front-End being introduced to the digital converter, there is a high possibility the processing capability of the A/D converter will be exceeded and overflow occurs.



Direct Sampling

Superheterodyne

Frequency components from the RF Front-End are converted to the IF frequency by the mixer circuit. The extraneous frequency components are attenuated by the IF Roofing filter, and the desired signals are converted to digital by the A/D converter. This method can significantly attenuate multiple strong interfering signals in the band in front of the A/D converter. The advantage is, the A/D converter becomes less susceptible to the unwanted strong signals interference.

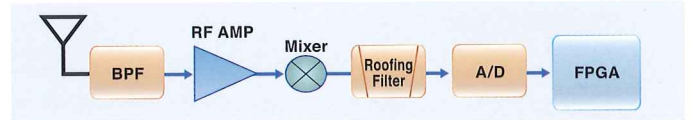

Superheterodyne

Hybrid SDR

In addition to direct sampling SDR which displays in-band information in real-time, the FTDX101 narrow band SDR is dedicated to narrowing the frequency components near the receiver signal while attenuating unnecessary components and then converting the net result to digital. For the display, the hybrid SDR configuration synthesizes digitized information and then displays it. By employing the hybrid SDR method, the performance of the entire receiver circuit is improved by using a down-conversion method in a narrow band circuit. In addition, utilizing the characteristics of the direct sampling method, wide area information is displaying showing the entire band in real-time.

If there is powerful AM station near your location or in challenging operating situations where there are a lot of strong signals in the band due to Contests, DX-pedition, etc., those signals outside the pass band can be sufficiently attenuated by the very effective roofing filter in the front stage of the A/D converter. This reduces the signal load on the A/D converter which is a bottleneck from the viewpoint of the entire receiving circuit. Therefore, interference is reduced making it possible to continue to effective operate even under such difficult conditions.



18 bit A/D converter for Narrow band SDR

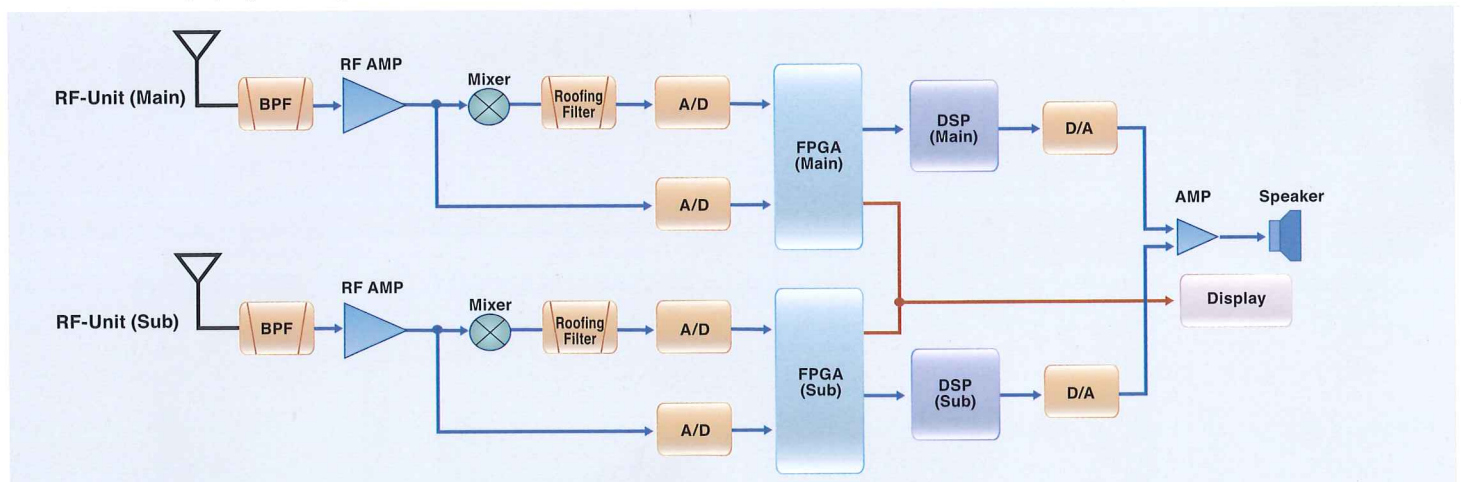

Completely Independent Dual Hybrid SDR System

FTdx101 Series Transceivers deliver Superior Operability and Visibility plus introduce numerous Incredible New Functions that will dramatically increase your On the-Air enjoyment

Front Panel Design Emphasizes Solid Superior Touch and Operability

Even with a Large 7-inch Touch Panel Display, the panel layout emphasizes quick visibility and operability as a First Priority. Primary important operation functions such as the Main VFO dial, Sub VFO dial, VC-TUNE, WIDTH/SHIFT are arranged near the center of the pane for easy access. An Active-Band-Indicator at the top of the VFO dial is just one example of the numerous layout considerations that were made for your operating efficiency and comfort.



7-inch Touch Panel Display

Waterfalls displays are one advantage of SDR technology. The FTdx101 utilizes the newly developed 3DSS (3-Dimension Spectrum Stream) system in addition to conventional Waterfalls display. The 3DSS displays the constantly changing band conditions in three dimensions with the frequency as the horizontal axis (X axis), the signal strength as the vertical axis (Y axis), and the time axis as the Z axis. Compared with the conventional Waterfalls, one quickly notices that the 3DSS displays the strength of the signal not only in color but also in three dimensions, so you can intuitively grasp changes in the situation in the band. 3DSS Waterfalls display is selectable as a monaural display that displays only the Main frequency band and dual displays that show the status of both the Main and Sub frequency bands.

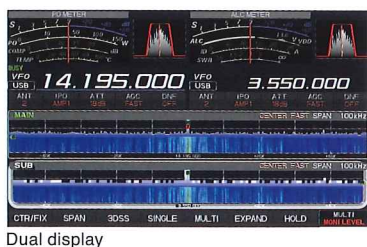
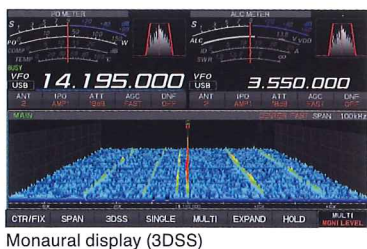

Filter Function Display provides constant Interference Control Awareness

On the upper part of the Large 7-inch Touch Panel Display, filter reduction function set-up display, pass-band condition and S-meter indication are shown independently for the Main and the Sub bands. The operator can grasp the operational status of WIDTH, SHIFT, NOTCH, CONTOUR controls with a quick glance. In addition to the operational state of the interference reduction functions, the information within the band from the DSP is vividly displayed showing the state of the spectrum in the pass band.



Filter function display

ACTIVE BAND INDICATOR

The Band Key is arranged at the top of the VFO dial so that the operation status of the Main band and Sub band can be confirmed at a glance. The band selected by the Main is blue, the band selected by the Sub is lit white LED. This blue and white coloring is the same coloring of the switch for each VFO dial. When transmitting, the LED on the transmitting side turns red, instantaneously recognizing which VFO is transmitting and prevents erroneous operation. If you press and hold the band key, the orange LED will be lit so you can display the band with the antenna connected or display the frequency used operated by a DX-pedition, as an example.



ACTIVE BAND INDICATOR

MPVD (MULTI PURPOSE VFO OUTER DIAL)

We placed a large multifunctional ring with high-grade aluminum scraping on the outside of the frequently use VFO dial. The ring allows control of Sub VFO frequency dial, VC-TUNE, Clarifier, VFO fine tuning, C/S (customer selection function: operator selects which function is assigned to the C/S and operated with one touch). The MPVD is a handy dial that allows you to adjust important functions in ever-changing HF communications without taking your hand off the VFO. The ring has a traditional Yaesu outstanding smooth and solid feeling when used.



Main dial and MPVD

Other Valuable Features

- ±0.1 ppm high-stability TCXO included
- Stable 200 W high power output ensured by an efficient heat dissipation design. A 50 Volt power supply and a heat sink dedicated to 200 W and a large cooling fan (MP version)
- CW Zero-in mode, convenient for CW operation and Spot function
- QMB (Quick Memory Bank) that can be used for each band
- SYNC (synchronizing) function convenient for split operation using two VFOs
- Function setting by MULTI function dial in addition to MPVD
- Adopted a knob shape reminiscent of the legendary FT-101 making it easy to determine RF gain control position
- Built-in speaker with large aperture of 3.62" (92 mm), high quality output designed for less operator fatigue even for long periods of operation
- MP version exclusive rich sound quality 3.94" (100 mm) external speaker and external AC power supply inside one enclosure
- Two USB terminals and one SD card slot are provided on the front panel for easy access

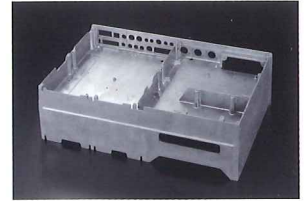

Aluminum die-cast chassis with high heat dissipation effect

Rear panel

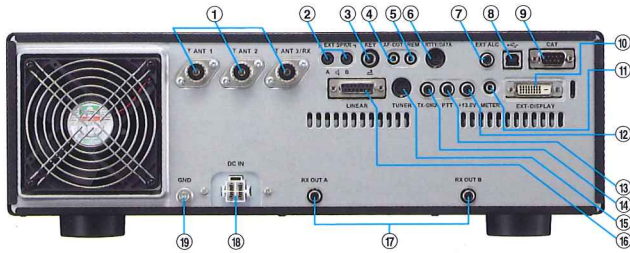

- ① **ANT 1/2/3**
Antenna Jacks (SO-239/M-Type)
*ANT 3: Selectable RX only
- ② **EXT SPKR**
External Speaker Jack
- ③ **KEY**
CW Key Jack
- ④ **AF-OUT**
Audio Output Jack
300mVpp ±50mV, 10kΩ
- ⑤ **REM**
Remote: FH-2 connection Jack
- ⑥ **RTTY/DATA**
RTTY/DATA Jack
- ⑦ **EXT ALC**
External ALC Jack
- ⑧ **USB Jack**
- ⑨ **CAT**
External Computer Control (RS-232C)
- ⑩ **EXT-DISPLAY**
External Display Connector (DVI-D)
- ⑪ **METER**
Analog Meter Jack
- ⑫ **+13.8V**
DC13.8V Output
- ⑬ **PTT**
External PTT Jack
- ⑭ **TX-GND**
TX Ground Jack
- ⑮ **TUNER**
External Antenna Tuner Jack
- ⑯ **LINEAR**
LINEAR AMPLIFIER Connection
- ⑰ **RX OUT A/B**
External Receiver Output Jack
- ⑱ **DC IN**
DC13.8V Input (FTDX101D)
External Power Supply Connector (FTDX101MP)
- ⑲ **GND**
Ground

Specifications

General			
TX Frequency Ranges	1.8 - 54MHz (Amateur bands only) 70 - 70.5MHz (UK Amateur bands only)		
RX Frequency Range	30kHz - 75MHz (operating) 1.8MHz - 29.699999MHz (Specified performance, Amateur bands only) 50MHz - 53.999999MHz (Specified performance, Amateur bands only) 70MHz - 70.500000MHz (Specified performance, UK Amateur bands only)		
Emission Modes	A1A (CW), A3E (AM), J3E (LSB/USB), F3E (FM), F1B (RTTY), G1B (PSK)		
Frequency Steps	1Hz, 10Hz (CW/SSB/AM), 100Hz (FM)		
Antenna Impedance	50Ω, unbalanced 16.7 - 150Ω, unbalanced (Tuner ON, 1.8 - 29.7MHz Amateur bands) 25 - 100Ω, unbalanced (Tuner ON, 50MHz Amateur band)		
Operating Temperature Range	+32°F to +122°F (0°C to +50°C)		
Frequency Stability	±0.1ppm (32°F to +122°F/0°C to +50°C, after 1min)		
Power Consumption	RX (no signal) 100VA (200W model), 3.5A (100W model) RX (signal present) 120VA (200W model), 4.0A (100W model) TX 720VA (200W model) TX 23A (100W model)		
Dimensions (W x H x D)	16.6" x 5.1" x 12.7" (420 x 130 x 322mm)		
Weight (Approx.)	29.8 lbs (13.5kg) 200W model, 26.5 lbs (12.0kg) 100W model		
Transmitter			
Power Output	5W - 200W (CW, LSB, USB, FM, RTTY, PKT) 200W model 5W - 50W (AM) 200W model 5W - 100W (CW, LSB, USB, FM, RTTY, PKT) 100W model 5W - 25W (AM) 100W model		
Modulation Types	J3E (SSB) Balanced A3E (AM) Low-Level (Early Stage) F3E (FM) Variable Reactance		
Maximum FM Deviation	±5.0kHz/±2.5kHz (Narrow)		
Harmonic Radiation	Better than -50dB (1.8 - 30MHz Amateur bands: Harmonics) Better than -50dB (1.8 - 30MHz Amateur bands: Others) Better than -66dB (50MHz Amateur band, 200W model) Better than -63dB (50MHz Amateur band, 100W model)		
SSB Carrier Suppression	At least 60dB below peak output		
Receiver			
Circuit Type	Double-conversion superheterodyne		
Intermediate Frequencies	1st IF 9.000MHz (MAIN), 8.900MHz (SUB) 2nd IF 24kHz (MAIN/SUB)		
Sensitivity (TYP)	SSB/CW (BW: 2.4kHz/10dB S+N/N) 0.16μV (1.8MHz - 30MHz, IPO=AMP2) 0.125μV (50MHz - 54MHz, IPO=AMP2) 0.16μV (70MHz - 70.5MHz, IPO=AMP2) AM (BW: 6kHz, 10dB S+N/N, 30% modulation @400Hz) 6.3μV (0.5MHz - 1.8MHz) 2μV (1.8MHz - 30MHz, IPO=AMP2) 1μV (50MHz - 54MHz, IPO=AMP2) 2μV (70MHz - 70.5MHz, IPO=AMP2) FM (BW: 12kHz, 12dB SINAD, 1kHz, 3.5kHzDEV) 0.25μV (28MHz - 30MHz, IPO=AMP2) 0.2μV (50MHz - 54MHz, IPO=AMP2) 0.25μV (70MHz - 70.5MHz, IPO=AMP2)		
Selectivity (TYP)	Mode	-6dB	-60dB
	CW (BW=0.5kHz)	0.5kHz or better	0.75kHz or less
	SSB (BW=2.4kHz)	2.4kHz or better	3.6kHz or less
	AM (BW=6kHz)	6kHz or better	15kHz or less
	FM (BW=12kHz)	12kHz or better	25kHz or less
Image Rejection	70dB or better (1.8 - 28MHz Amateur bands) 60dB or better (50MHz Amateur band)		
Maximum Audio Output	2.5W into 4Ω with 10% THD		
Audio Output Impedance	4 - 16Ω (4Ω: nominal)		
Conducted Radiation	Less than 4nW		

This device has not been approved by the FCC. This device may not be offered for sale or lease or be sold or leased until approval of the FCC has been obtained. The information shown is preliminary and may be subject to change without notice or obligation.

About this brochure: We have made this brochure as comprehensive and factual as possible. We reserve the right, however, to make changes at any time in equipment, optional accessories, specifications, model numbers, and availability. Precise frequency range may be different in some countries. Some accessories shown herein may not be available in some countries. Some information may have been updated since the time of printing; please check with your Authorized Yaesu Dealer for complete details.

YAESU
The radio

YAESU MUSEN CO., LTD. <http://www.yaesu.com/jp>

Tennozu Parkside Building
2-5-8 Higashi-Shinagawa, Shinagawa-ku, Tokyo 140-0002, Japan

YAESU USA <http://www.yaesu.com>

US Headquarters 6125 Phyllis Drive, Cypress, CA 90630, U.S.A.

YAESU UK <http://www.yaesu.co.uk>

Unit 12, Sun Valley Business Park, Winnall Close
Winchester, Hampshire, SO23 0LB, U.K.



2018.0910YS (U/EXP/EU) B9200863 Printed in Japan